



Overseas Affiliates

U.S.A.

RICOH CORPORATION
5 Dedrick Place
West Caldwell, New Jersey
07006
Phone: +1-973-882-2000

The Netherlands

RICOH EUROPE B.V.
Groenelaan 3, 1186 AA,
Amstelveen
Phone: +31-(0)20-5474111

United Kingdom

RICOH UK LTD.
Ricoh House,
1 Plane Tree Crescent,
Feltham,
Middlesex, TW13 7HG
Phone: +44-(0)181-261-4000

Germany

RICOH DEUTSCHLAND
GmbH
Mergenthalerallee 38-40,
65760 Eschborn
Phone: +49-(0)6196-9060

France

RICOH FRANCE S.A.
383, Avenue du Général
de Gaulle
BP 307-92143 Clamart
Cedex
Phone: +33-(0)1-40-94-38-38

Spain

RICOH ESPAÑA S.A.
Avda. Litoral Mar, 12-14,
08005 Barcelona
Phone: +34-(0)93-295-7600

Italy

RICOH ITALIA SpA
Via della Metallurgia 12,
37139 Verona
Phone: +39-(0)45-8181500

Hong Kong

RICOH HONG KONG LTD.
23/F., China Overseas
Building,
139, Hennessy Road,
Wan Chai, Hong Kong
Phone: +852-2862-2888

Singapore

RICOH ASIA PACIFIC
PTE.LTD.
260 Orchard Road,
#15-01/02 The Heeren,
Singapore 238855
Phone: +65-830-5888

SUPPLIES MODEL NAME

The correct model name of supplies for
your Bizworks is:
RICOH TONER CASSETTE TYPE 1120D BLACK

RICOH CO., LTD.

15-5, 1 chome, Minami-Aoyama, Minato-ku, Tokyo
Phone: Tokyo 3479-3111

Printed in The Netherlands

EE G026-8500

RICOH

RICOH
Bizworks™
406e/406eDF

Operation Manual

Read this manual carefully before you use this product and keep it handy for future reference. For safety, please follow the instructions in this manual.

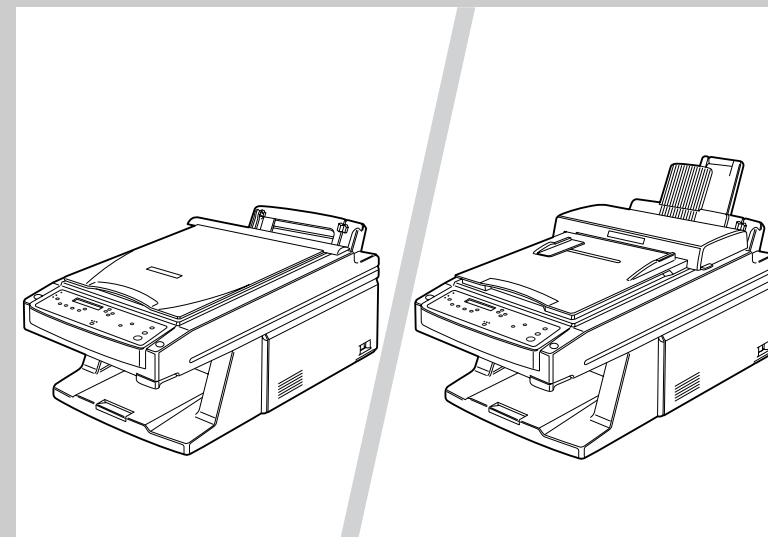

Introduction

This manual contains detailed instructions on the operation and maintenance of this machine. To get maximum versatility from this machine, all operators should carefully read and follow the instructions in this manual. Please keep this manual in a handy place near the machine.

Please read the safety information on pages i - iii of this manual. It contains Important Information related to user safety and preventing equipment problems.

Operator Safety:

This machine is considered a class 1 laser device, safe for office/ EDP use. The machine contains a 5-milliwatt, 765 - 805 nanometer wavelength, GaAlAs laser diodes. Direct (or indirect reflected) eye contact with the laser beam might cause serious eye damage. Safety precautions and interlock mechanisms have been designed to prevent any possible laser beam exposure to the operator.

The following label is attached on the machine.
This label can be found when opening the bypass tray.

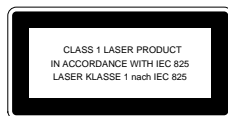

Laser Safety:

The optical housing unit can only be repaired in a factory or at a location with the requisite equipment. The laser subsystem is replaceable in the field by a qualified Customer Engineer. The laser chassis is not repairable in the field. Customer engineers are therefore directed to return all chassis and laser subsystems to the factory or service depot when replacement of the optical subsystem is required.

Notes:

- Model names for the machines do not appear in the following pages. Check the type of your machine before reading this manual.
Type 1 Bizworks 406e
Type 2 Bizworks 406eDF
- Some illustrations may be slightly different from your machine.
- Certain types may not be available in some countries. For details, contact your local dealer.

Two kinds of size notation are employed in this manual. With this machine refer to the metric version.

For good print quality, Ricoh recommends that you use genuine Ricoh toner.

Ricoh shall not be responsible for any damage or expense that may result from the use of parts other than genuine Ricoh parts in your Ricoh office product.

Power Source: 220 ~ 240 V, 50/60 Hz, 2.2 A

Please make sure to connect the power cord to a power source as above. For details about power connection, refer to page 8.

Trademarks

Microsoft®, Windows®, and MS-DOS® are registered trademarks of Microsoft Corporation in the United States and/or other countries.

Other product names used herein are for identification purposes only and might be trademarks of their respective companies. We disclaim any and all rights in those marks.



Declaration of Conformity

"The Product complies with the requirements of the EMC Directive 89/336/EEC and the Low Voltage Directive 73/23/EEC."

In accordance IEC 60417 this machine uses the following symbols for the main switch:

- I** means POWER ON.
- O** means POWER OFF.

Safety Information

When using your machine, the following safety precautions should always be followed.

Types of warnings used in this manual



WARNING

Ignoring this warning could cause serious injury or even death.



CAUTION

Ignoring this caution could cause injury or damage to property.

Symbol examples



The \triangle symbol means a situation that requires you take care.



The \circ symbol means you **MUST NOT** carry out this operation.
This example means "Do not take apart."









The \bullet symbol means you **MUST** perform this operation.
This example means "You must remove the wall plug."







Microsoft[®], Windows[®], and MS-DOS[®] are registered trademarks of Microsoft Corporation in the United States and/or other countries.

Other product names used here in are for identification purposes only and might be trademarks of their respective companies. We disclaim any and all rights in those marks.

WARNING:

	<ul style="list-style-type: none">• Use of controls or adjustment or performance of procedures other than those specified in this manual may result in hazardous radiation exposure.
	<ul style="list-style-type: none">• Only connect the machine to the power source described on the inside of the front cover.• Avoid multi-wiring.• Do not damage, break or make any modifications to the power cord. Do not place heavy objects on it, pull it hard or bend it more than necessary. These actions could cause an electric shock or fire.• Do not plug or unplug the power cord with your hands wet. Otherwise, an electric shock might occur.
	<ul style="list-style-type: none">• Make sure the wall outlet is near the machine and freely accessible so that in event of an emergency it can be unplugged easily.
	<ul style="list-style-type: none">• Do not remove any covers or screws other than those specified in this manual. Some parts of the machine are at a high voltage and could give you an electric shock. Also, reflected eye contact with the laser beam may cause serious eye damage. When the machine needs to be checked, adjusted, or repaired, contact your service representative.• Do not take apart or attempt any modifications to this machine. There is a risk of fire, electric shock, explosion or loss of sight.
	<ul style="list-style-type: none">• If the machine looks damaged or breaks down, smoke is coming out, there is a strange smell or anything looks unusual, immediately turn off the power switch then unplug the power cord from the wall. Do not continue using the machine in this condition. Contact your service representative.• If metal, liquid or foreign matter falls into the machine, turn off the power switch, and unplug the power cord. Contact your service representative. Do not keep using the machine with a fault or defect.
	<ul style="list-style-type: none">• Do not put any metal objects or containers holding water (e.g. vases, flower-pots, glasses) on the machine. If the contents fall inside the machine, a fire or electric shock could occur.
	<ul style="list-style-type: none">• Do not incinerate used toner or toner cassettes. Toner dust might ignite when exposed to an open flame. Dispose of the used toner cassettes according to local regulations for plastics.

CAUTION:

	<ul style="list-style-type: none">• Keep the machine away from humidity and dust. A fire or an electric shock might occur.• Do not place the machine on an unstable or tilted surface. If it topples over, it could cause injury.
	<ul style="list-style-type: none">• When you move the machine, unplug the power cord from the wall outlet to avoid fire or electric shock.• When the machine is not be used for a long time, unplug the power cord.
	<ul style="list-style-type: none">• When you pull out the plug from the socket, grip the plug to avoid damaging the cord and causing fire or electric shock.
	<ul style="list-style-type: none">• If you use the machine in a confined space, make sure there is a continuous air turnover.
	<ul style="list-style-type: none">• Do not reuse stapled paper. Do not use aluminium foil, paper containing carbon or any other conductive paper. Otherwise, a fire might occur.
	<ul style="list-style-type: none">• When removing misfed paper, or replacing the toner cassette and the cleaning pad, do not touch the fusing section because it could be very hot.
	<ul style="list-style-type: none">• This machine has been tested for safety using this supplier's parts and consumables. We recommend you only use these specified supplies.

Energy Star program

Energy Star®



As an Energy Star partner, we have determined that this machine model meets the Energy Star Guidelines for energy efficiency.

The Energy Star Guidelines intend to establish an international energy-saving system for developing and introducing energy-efficient office equipment to deal with environmental issues, such as global warming.

When a product meets the Energy Star Guidelines for energy efficiency, the Partner shall place the Energy Star logo onto the machine model.

This product was designed to reduce the environmental impact associated with printing equipment by means of energy-saving features such as Low Power mode.

- **Low Power Mode**

This machine automatically lowers its power consumption 15 minutes after the last printing job has been completed. To exit Low Power mode, press any key on the operation panel.

The machine returns to the ready condition in about 22 seconds. To change the low Power delay, see page 60.

Specification

	Type 1, 2	
Low Power Mode (Economy Mode)	Power consumption	15 W
	Default delay	15 min.
	Recovery time	22 sec.

Recycled paper

Please contact your sales or service representative for recommended recycled paper types that may be used in this machine.

Contents

Safety Information	i
Energy Star program	iv
Part Names	viii
Operation Panel	x
1. SETTING UP	
Package Contents	1
Location	1
Installing the Starter Toner Cassette	2
Unlocking the Scanner Lock	3
Installing the Upper Paper Tray	4
Other Settings for Type 2	5
To remove the protective sheet	5
To install the document output tray	5
To pull out the output tray extension	6
Connecting to a computer	7
Turning On the Machine	8
2. GETTING ACQUAINTED	
Paper and Other Media	9
Loading Paper	10
To load plain paper into the upper paper tray	10
To load small size paper	12
Loading Other Media	14
To load envelopes	14
To load transparencies	14
To load label paper	14
Connecting a Second Printer (Additional Printer)	15
To connect to a second printer	15
Installing the Paper Feed Unit (Option)	16
Paper Feed Unit Part Names	16
To install the Paper Feed Unit	16
To load paper into the paper feed unit	18
To change the paper size	19
To specify the paper size	19
To install the paper size indicator	20

To select the paper source	20
Upgrading Memory	21

3. PRINTING AND SCANNING

Setting up	23
Installing the Software Drivers	23
Features You Can Access From the Printer Driver	25
Using the Second Printer (Additional Printer)	26
To print to the second printer	26

4. COPYING

Making a Copy	27
Making Multiple Copies	28
Making a Book Copy	29
Reduction and Enlargement	30
To set the reduction factor	30
To set the enlargement factor	31
Zoom (In 1% Increments)	32
To use zoom	32
Adjusting the Copy Image	33
To select the resolution/photo setting	33
To adjust the image density	34
Setting an Original on the ADF (Type 2 only)	35
Sorting Output (Type 2 only)	37
To turn sorting on and off	37

5. TROUBLESHOOTING

General problems (printing, copying, scanning and Error messages)	39
Clearing a Paper Misfeed	44
Paper feed unit	48
When paper will not feed	49

6. USER MAINTENANCE

Daily Maintenance	51
Replacing the Toner Cassette And the Cleaning Pad	52
Storage	55
Paper	55
Toner Cassette	55

7. TECHNICAL REFERENCE	
Printing the Help List	56
Selecting the Language	57
Selecting 300 dpi or 600 dpi.....	58
Economy Mode	60
Changing the Economy Mode	60
Selecting Toner Save Mode	61
8. SPECIFICATIONS	62
Index	65

Part Names

Type 1

The following describes the Type 1 machine. This information also applies to the Type 2 machine, except where specifically noted in the next page.

Platen cover

Lift this cover to access the exposure glass when you want to place an original on it for copying and scanning.

Exposure glass

Place originals on this glass face down.

Operation panel

Key panel for controlling the machine.

Output tray extension

Pull out to support paper output from the machine.

Output tray

Prints are delivered here. This tray can hold up to 50 sheets.

Upper paper tray

Holds up to 100 sheets of plain paper.

Top unit

Power switch

Turns the machine on and off.

Top release lever

Pull to release the top unit and open it.

Scanner lock

Locks the scanner to prevent damage during transport. Be sure to release this lock before using the machine.

Small size paper feed access panel

This panel can be lowered to provide easier handling when printing on or copying to small size paper.

Power socket

SIMM cover

Open this cover when you want to install a SIMM and expand memory.

Second printer (Additional Printer) port

You can connect a second printer to this port.

Computer port

Connect your computer here.

Type 2

The following describes the Type 2 machine.

Automatic document feeder (ADF)

Holds up to 10 sheets of paper for automatic feeding. Place originals face down.

Document guides

Slide the left guide to fit the size of the paper you are feeding.

Exposure glass

Operation panel

Output tray extension

Top release lever

Upper paper tray

Original guide

Guides the original correctly into the machine. Make sure your original fits under this guide.

Top unit

Power switch

Platen cover

Lift this cover to access the exposure glass when you want to scan a page from a book, magazine, or any other original that cannot be fed using the ADF.

Output tray

Document output tray

Scanned documents are delivered here.

Scanner lock

Upper tray extension

Extend to support originals.

Small size paper feed access panel

SIMM cover

Power socket

Second printer (Additional Printer) port

Computer port

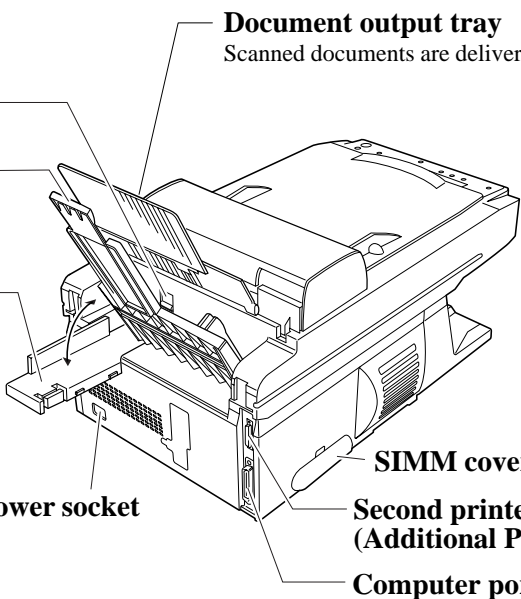
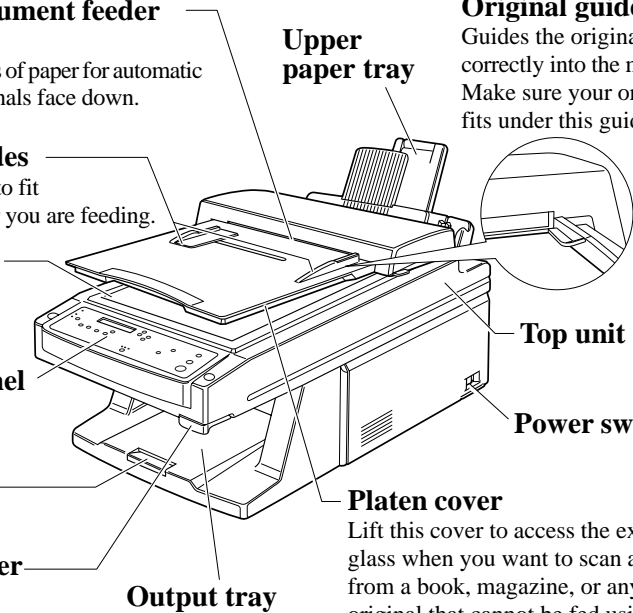

Operation Panel

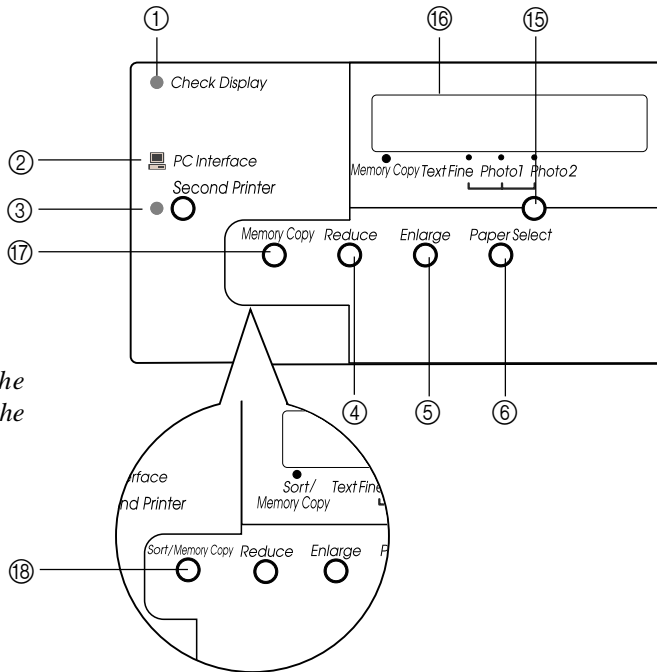

Note

Be sure to panel the protective sheet from the operation panel

① Check Display

This indicator lights up to alert you to read the message on the display.

② PC Interface

This indicator lights while the machine is receiving data from a connected computer.

③ Second Printer

Pressing this key switches between printing on the machine (Second Printer indicator off) and printing on a second printer connected to the machine (Second Printer indicator on).

④ Reduce

Press this key to reduce an image during copying. Available reduction ratios are: 50%, 71%, 82%, 87% and 93%.

⑤ Enlarge

Press this key to enlarge an image during copying. Available enlargement ratios are: 115%, 122%, 141% and 200%.

⑥ Paper Select

Press this key to specify the paper size. When the paper feed unit (option) is installed, press this key to switch between paper sources.

⑦ Density key

Press this key to select the image density settings: Darker, Auto, Lighter.

⑧ Quantity keys

Press these keys to specify the number of copies or to change numeric values on the display.

⑨ Start

Press this key to start an operation.

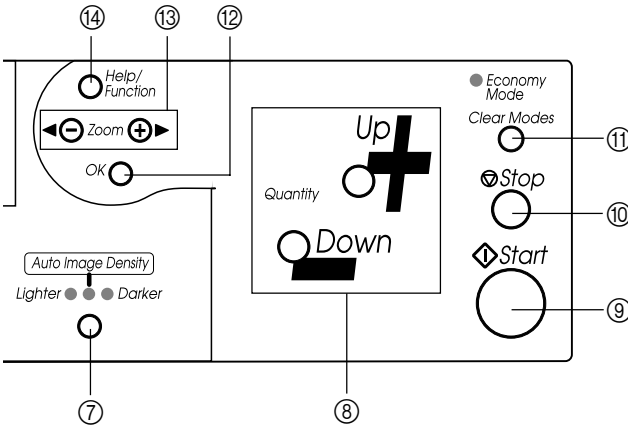

10 Stop

Press this key to interrupt the current ongoing procedure and return to the stand by state. This key operates as a kind of escape key. Holding down this key for 3 seconds resets the printer mode.

**11 Economy Mode/
Clear Modes key**

Pressing this key cancels the ongoing operation and clears the settings of the current mode to their initial defaults. Holding down this key for about one second switches the Economy Mode on and off. Refer to “Economy Mode” on page 60.

12 OK

Press this key to execute an operation that is prompted by a message on the display.

13 Zoom

In copy mode, press these keys to fine-tune the preset reduction and enlargement ratios. Also use to select function settings and navigate the function menus.

14 Help/Function

Press this key and then input a function number to perform various settings and help list printing functions.

15 Copy Mode key

Press this key to specify the Copy Mode. A pointer (▼) appears on the display to indicate the current Text Fine/Photo1/Photo2 setting.

16 Display

Displays messages and prompts during operation.

17 Memory Copy (Type 1 only)

Press this key to select Memory Copy. (Your original will be scanned only once when making multiple copies.)

18 Sort/Memory Copy (Type 2 only)

Press this key to turn Sorting and Memory Copy on and off. Sorting is activated when the pointer is visible on the display above Sort/Memory Copy.

This page is intentionally blank

1. SETTING UP

Package Contents

Make sure that all of the items shown in the Package Contents sheet that comes with the machine are included.

⚠ WARNING	
❗	Make sure the wall outlet is near the machine and freely accessible so that in event of an emergency it can be unplugged easily.
🚫	Do not put any metal objects or containers holding water (e.g. vases, flowerpots, glasses) on the machine. If the contents fall inside the machine, a fire or electric shock could occur.
⚠ CAUTION	
🚫	Keep the machine away from humidity and dust. A fire or an electric shock might occur.
🚫	Do not place the machine on an unstable or tilted surface. If it topples over, it could cause injury.
❗	If you use the machine in a confined space, make sure there is a continuous air turnover.

1. SETTING UP

Location

Environment

	Acceptable	Recommended
Temperature	10 to 35°C (50 to 95°F)	15 to 25°C (59 to 77°F)
Humidity	15 to 80%	30 to 70%

- The machine must be level within 3mm (0.11") both front to rear and left to right.

Locations to Avoid

- Avoid exposed to direct sunlight or strong light (more than 2,000 lux.).
- Avoid directly exposed to cool air from air conditioner's or heated air from heater's. Sudden temperature changes can cause condensation to form inside the machine.
- Avoid where the machine might be subjected to frequent strong vibration.
- Places higher than 2,500m (8,221ft.) above sea level.

Machine Clearance

Place the machine near the wall outlet, providing minimum clearance as shown.

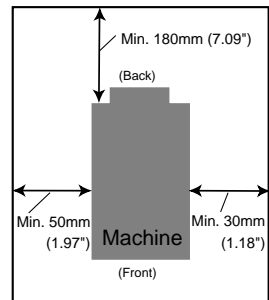

Installing the Starter Toner Cassette

- 1 Pull the top release lever (①) and open the top unit (②).**

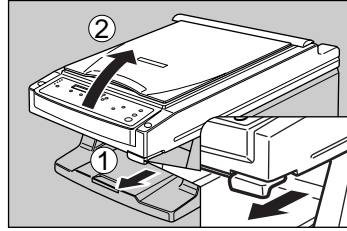

- 2 Hold the starter toner cassette by its handle, and remove it from its vinyl bag.**

 CAUTION
Keep all plastic bags out of the reach of children.

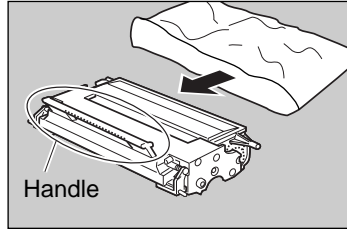

Important!

Be sure to hold the starter toner cassette by its handle.

Note

Keep the vinyl bag for later repackaging when necessary.

- 3 Holding the starter toner cassette by its handle, gently shake it side to side 5 or 6 times to evenly distribute the toner inside.**

Important!

Be sure to hold the starter toner cassette by its handle.

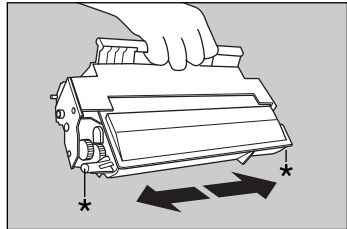

- 4 Look inside the machine and note the locations of the arrows that indicate the toner cassette guides on either side.**

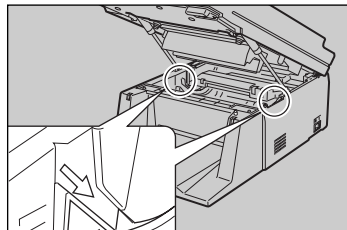

- 5** Make sure the plastic pins (marked with “*” in the illustration next to step 3) on either side of the starter toner cassette slide along the guides inside the machine.

 **Note**

Be sure to hold the starter toner cassette by its handle.

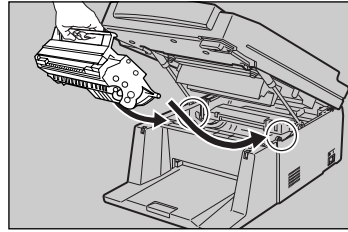

- 6** To close the top unit, press down firmly but gently on both sides of it until the top unit closes and clicks securely into place.

 **Note**

Background gray cast is sometimes evident just after installing a new toner cassette.

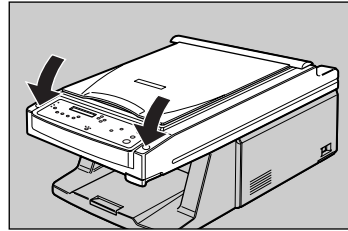

Unlocking the Scanner Lock

 **Important**

Be sure to unlock the scanner lock before using the machine.
The machine will not operate correctly if the scanner lock is not unlocked.

- 1** Unlock the scanner lock which is located at the back of the machine.

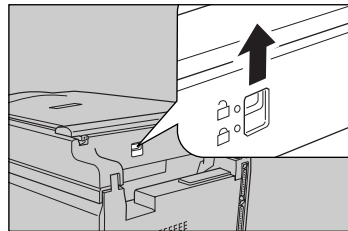

Installing the Upper Paper Tray

- 1** Look at the rear of the machine and note the locations of the slots for insertion of the upper paper tray on both sides.

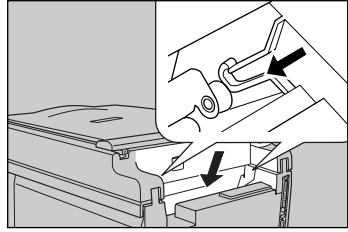

- 2** To install the upper paper tray, press down on both sides of the tray, making sure that it is inserted as far as it will go.



Note

Paper will not be fed correctly into the machine if the upper paper tray is not inserted all the way in.

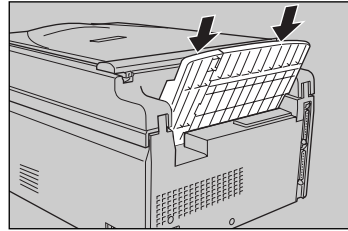

Other Settings for Type 2

To remove the protective sheet

- 1 Open the ADF cover (①) and then remove the protective sheet (②).

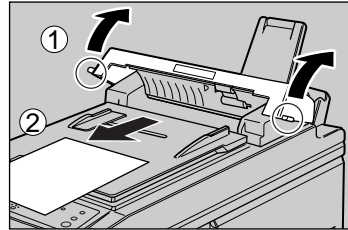

- 2 Close the ADF cover and make sure it locks securely into place.

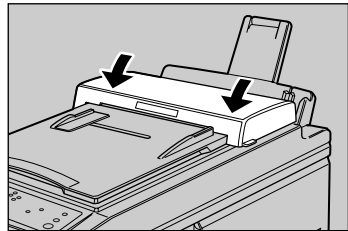

To install the document output tray

- 1 Look at the rear of the machine to confirm where the document output tray should fit.

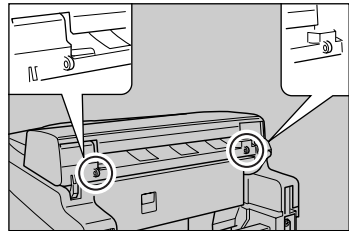

- 2 Insert the pin at one side of the tray by gently bending the document tray until it fits in the insert hole.

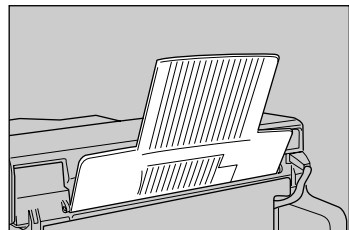

- 3** Make sure the small pieces of plastic film curl upwards as shown.

! *Important!*

The original will not be delivered properly, if the films are not set as shown.

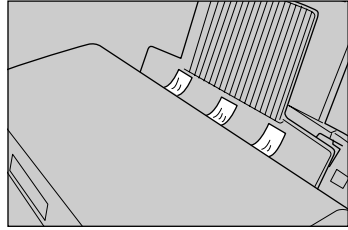

To pull out the output tray extension

- 1** To pull out the output tray extension as shown.

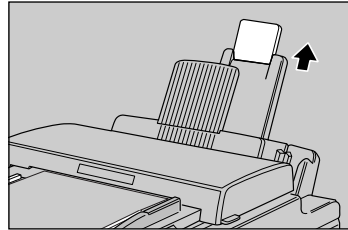

Connecting to a computer

Important!

Make sure that the power of both the machine and your computer is turned off before making the connection.

- 1** Plug one end of the your parallel cable into the lower port on the side of the machine, and secure it in place as shown in the illustration.

Note

- *The machine must be connected to a computer for printing.*
- *Use the cable that comes with the machine to connect to your computer.*

- 2** Connect the other end of the parallel cable to your computer's parallel printer port.

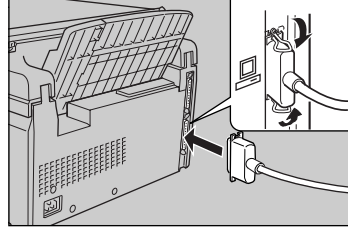

Turning On the Machine

WARNING



- Only connect the machine to the power source described on the inside of the front cover.
- Avoid multi-wiring.
- Do not damage, break or make any modifications to the power cable. Do not place heavy objects on it, pull it hard or bend it more than necessary. These actions could cause an electric shock or fire.
- Do not plug or unplug the power cord with your hands wet. Otherwise, an electric shock might occur.

Important!

When you turn on the machine for the first time after the installation, make sure that no paper is loaded beforehand.

- 1** Attach the power cable to the machine and plug the other end into a outlet.

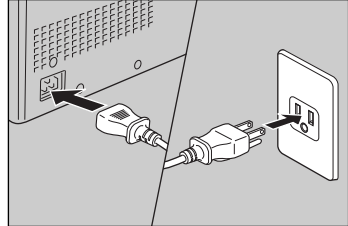

- 2** Turn on the machine.

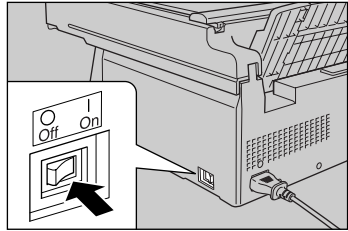

2. GETTING ACQUAINTED

Important!

The default display language is English. For how to change to your preferred language, see page 57.

Paper and Other Media

The machine supports printing on the following types of paper/media from the upper paper tray.

Refer to the following pages for details.

Paper/Media type (Paper size)		Display	Page
Plain paper	A4 (210mm × 297mm)	A4	p.10
	A5 (148mm × 210mm)	A5	p.10
	F4 (8 ¹ / ₄ " × 13")	8 ¹ / ₄ × 13	p.10
	Letter (8 ¹ / ₂ " × 11")	Letter (8 ¹ / ₂ × 11)	p.10
	Legal (8 ¹ / ₂ " × 14")	Legal (8 ¹ / ₂ × 14)	p.10
Envelopes	C5 Envelope (162mm × 229mm)	C5 Env	p.12, 14
	C6 Envelope (114mm × 162mm)	C6 Env	p.12, 14
	DL Envelope (110mm × 162mm)	DL Env	p.12, 14
Transparencies			p.14
Label paper			p.14

Note

Do not attempt to use the following types of paper: wrinkled or creased paper, curled or rolled paper, paper containing carbon, carbon-backed paper, coated paper, onion skin or other very thin paper.

CAUTION

 Do not reuse stapled paper. Do not use aluminium foil, paper containing carbon or other conductive paper. Otherwise, a fire might occur.

Loading Paper

After you have set up the machine you need to load paper then specify the paper size using the procedure below.

Important!

When loading paper into the upper paper tray, do not load more than 100 sheets of plain paper (80 g/m² or 20 lb). Overloading the upper paper tray can cause misfeeds.

To load plain paper into the upper paper tray

- 1** Fan the stack of paper to make sure that all pages are free and are not sticking together. The upper paper tray holds up to 100 sheets of plain paper (80 g/m² or 20 lb).

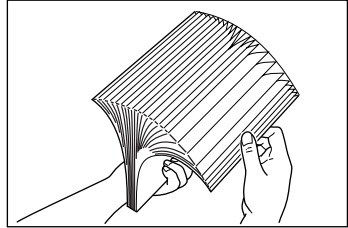

- 2** Straighten up all four sides of the stack, by tapping them on a desk or table top.

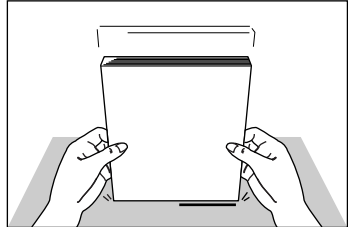

- 3** Set paper into the upper paper tray. Make sure that the top of the stack is not higher than the limit mark on the tray guide.

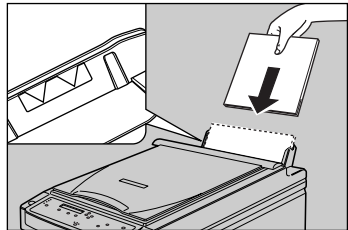

- 4** Squeeze the tray guide and slide it against the edge of the stack.

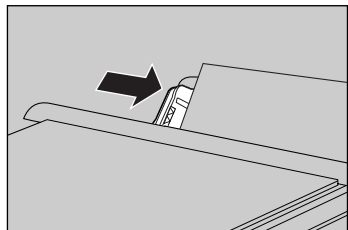

5 Press  *Help/Function*.

Prt Help List ▶

6 Press *Zoom*  ▶.



1 Tray Pap. Size ▶

 **Note**

If the paper feed unit (option) is installed, refer to page 19 for details on how to specify the paper size.

7 Press *OK* .

Tray guide OK? 

8 After pressing *OK* , press *Zoom*  ▶ or  *Zoom* until the desired size appears.

A4 ? ▶



9 When the correct paper size is on the display, press *OK* . If the paper feed unit (option) (page 17) is installed, you can also select its paper size at this time.

Registered

 **Note**

Do not carry out any operations while “Registered” appears on the display.

 **Tip**

If the paper feed unit (option) is not installed, you can press *PaperSelect*  in place of  *Help/Function* in step **5**. Next, skip step **6** and **7**, and jump directly to step **8**.

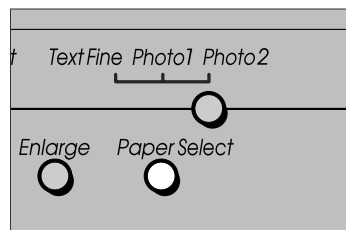

To load small size paper

Note

We recommend that you always feed small size paper vertically, with one of its shorter edges feeding into the machine.

- 1** Remove all paper before loading small size paper in the upper paper tray.

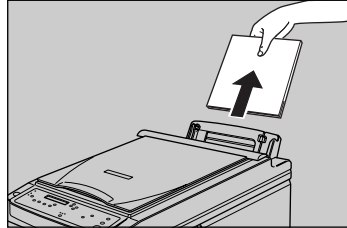

- 2** Open the small panel on the back of the machine by unlatching it as shown in the illustration. Opening the small panel makes it easy to handle small size paper.

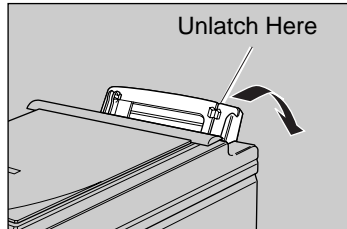

- 3** Set paper into the upper paper tray. Make sure that the top of the stack is not higher than the limit mark on the tray guide.

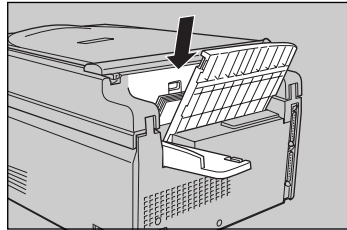

- 4** After setting the paper into the tray, raise the small panel until it snaps securely into place.

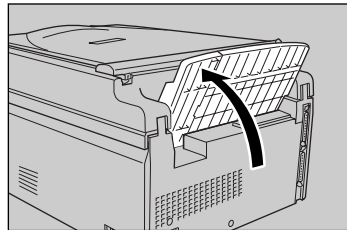

5 Press  *Help/Function*.

Prt Help List ▶

6 Press Zoom .



1 Tray Pap. Size ▶

 **Note**

If the paper feed unit (option) is installed, refer to page 19 for details on how to specify the paper size.

7 Press *OK* .

Tray guide OK? 

8 After pressing *OK* , press Zoom  or  *Zoom* until the desired size appears.

A5  ? ▶



9 When the correct paper size is on the display, press *OK* .

Registered

 **Note**

Do not carry out any operations while “Registered” appears on the display.

 **Tip**

If the paper feed unit (option) is not installed, you can press *Paper Select*  in place of  *Help/Function* in step **5**. Next, skip step **6** and **7**, and jump directly to step **8**.

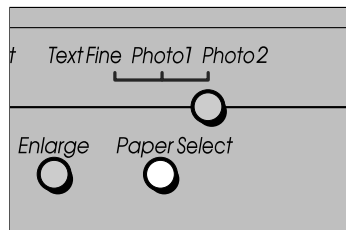

 **Note**

• Be sure to specify the paper size before printing on A4 or Letter paper again.

Loading Other Media

Use the following procedures to load envelopes, transparencies, and label paper.

To load envelopes

Load up to 5 envelopes at a time, using the same procedure for loading small size paper on page 12.

- *Insert envelopes print side up with the stamp position as shown.*

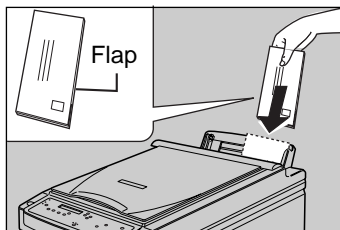

- *Envelope flaps should be securely folded down, so the envelope is “closed”. This is especially important when printing on envelopes with adhesive on the flaps, because heat generated during the printing process can cause the adhesive to melt and get on rollers.*

Note

Refer to the paper select operation on page 13.

To load transparencies

Load only one transparency at a time, using the plain paper loading procedure on page 10 for large transparencies, and the small paper loading procedure on page 12 for small transparencies.

Note

Refer to the paper select operation on page 11 for large transparencies or page 13 for small ones.

To load label paper

Load only 10 sheets of label paper at a time, using the plain paper loading procedure on page 10.

Note

Refer to the paper select operation on page 11.

Connecting a Second Printer (Additional Printer)

The machine features a port that you can use to connect your current printer as a second printer (additional printer). Once you do, you have a selection of this machine or the second printer at the touch of **Second Printer** key.

Note

Make sure that the power of your computer is turned off before making the connection.

To connect to a second printer

- 1 Turn off both the machine and your second printer.

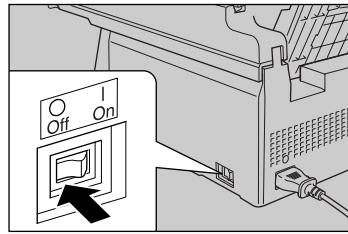

- 2 Connect one end of a parallel interface cable to your second printer.

- 3 Connect the other end of the cable to the second printer port, securing it in place with the screws.

Note

- It requires a standard 36-pin parallel cable compliant with IEEE 1284.
- Refer to page 26 for details on using the second printer.

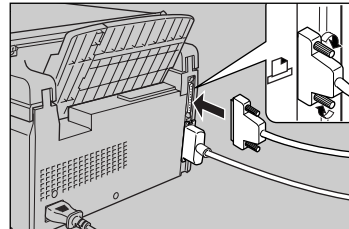

Installing the Paper Feed Unit (Option)

This section describes how to install the paper feed unit (option) and how to load paper in it. Addition of a paper feed unit provides you with a second paper source that holds up to 250 sheets of A4 or Letter size paper.

Important!

Make sure that machine power is turned off and that the power cord is unplugged from the power socket before installing the paper feed unit.

Paper Feed Unit Part Names

- ① Front guide
- ② Side guide
- ③ Limit mark
- ④ Paper size indicator
- ⑤ Connector
- ⑥ Corner guides
- ⑦ Metal plate

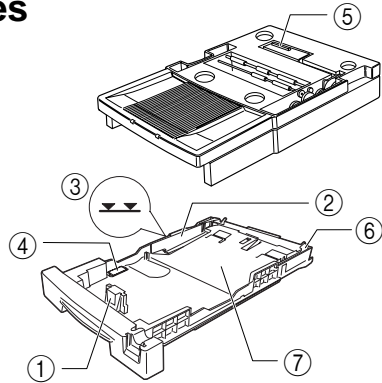

To install the Paper Feed Unit

- 1** Remove all the packing tapes from the paper feed unit and pull the paper tray out of the unit.

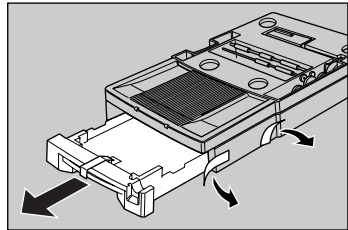

- 2** After removing all tapes and cardboard from inside of the paper tray, insert the tray back into the machine until it locks into place. Locate the paper feed unit where you plan to use the machine.

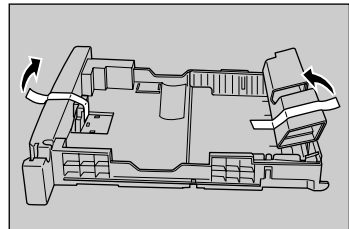

Note

Be sure to place the paper feed unit on a level surface.

- 3** The machine has handhold at the locations shown in the illustration. Note that the illustration shows the machine as viewed from above.

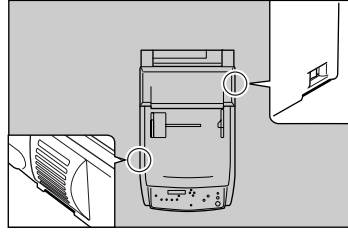

- This illustration shows the handhold location on the right side of the machine.
- This is the handhold location on the left side of the machine.

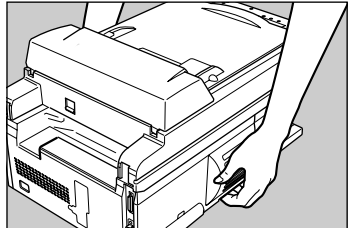
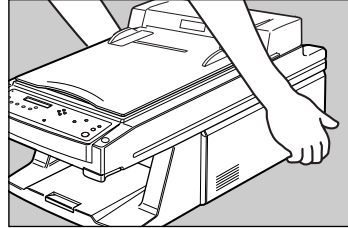

- 4** Carefully lower the machine onto the paper feed unit, making sure that the dowels on the paper feed unit fit into holes in the bottom of the machine properly.

⚠ CAUTION

When lifting the machine, make sure your hands are at the locations indicated by “*” in the illustration. This protects against pinching your fingers between the machine and paper feed unit.

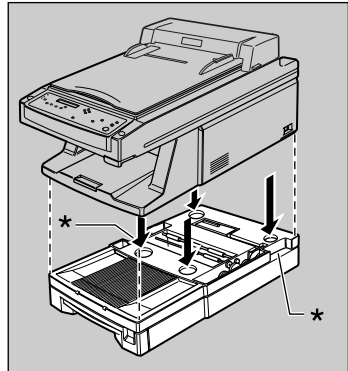

Note

After the above installation, attach the power cord to the machine, and plug the other end into an outlet. Refer to page 8 for details.

To load paper into the paper feed unit

You can load either A4 or Letter size paper into the paper feed unit. Refer to page 19 for details on how to change the positions of the paper guides inside of the tray to match the type of paper you are using.

- 1** Pull out the paper tray and remove it from the paper feed unit.

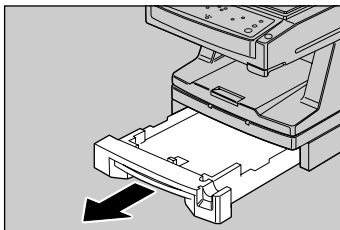

- 2** Press down on the metal plate in the bottom of the paper tray until the plate locks into place with a “click”.

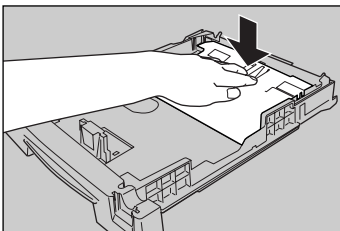

- 3** Up to 250 sheets of plain paper (80 g/m² or 20 lb) can be inserted into the paper tray as shown in the illustration. Make sure that the top of the stack is not higher than the limit mark on the side fence.

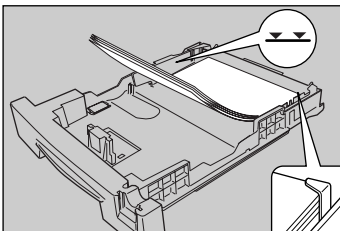

 **Note**

Make sure the leading corners of the paper fit under the corner guides.

- 4** Slide the paper tray back into the paper feed unit until it locks into place.

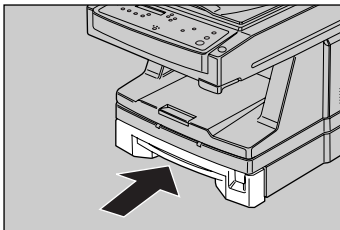

To change the paper size

Use the following procedure to set the positions of the paper guides inside the paper tray for either A4 or Letter paper.

- 1** Squeezing in on both sides of the front guide, slide it to the correct position for the desired paper size.

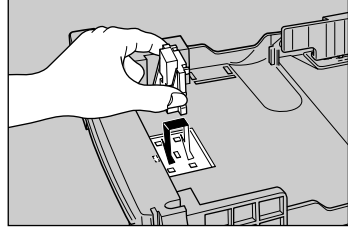

- 2** Squeezing in on both sides of the side guide, slide it to the correct position for the desired paper size.

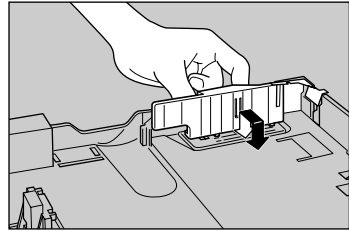

Important!

Whenever you change the paper size, be sure to also specify the paper size using the operation panel.

To specify the paper size

After you install the paper feed unit (option), you can select between the upper paper tray and the paper feed unit as the paper source, and specify the size of paper in the paper feed unit.



- 1** Press the  *Help/Function*.



Prt Help List ▶

- 2** Press Zoom  ▶ .

1 Tray Pap. Size ▶

3 Press **OK** .Lower Tray?  **Note**

The actual message that appears on the machine's display depends on the paper source you last used. If "Upper Tray?" appears, press **Zoom**  or  **Zoom** to display the "Lower Tray?" message before proceeding with step **4**.



4 After pressing **OK** , press **Zoom**  or  **Zoom** until the desired size appears.A4 ? **5** When the correct size is on the display, press **OK** .

Registered

 **Note**

Do not carry out any operations while "Registered" appears on the display.

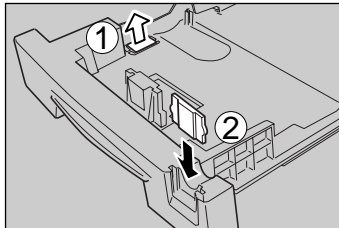
100% L 01

To install the paper size indicator**1** Break off the paper size indicator (①). Positioning the indicator so the side that shows the paper size you are using (A4 or Letter) is facing outwards, insert it into the front of the paper tray (②).**To select the paper source****1** Press **PaperSelect**  until the desired paper source appears.

100% U 01

The upper paper tray is selected when "U" is on the display, and the paper feed unit is selected when "L" is on the display.

100% L 01

 **Note**

Refer to page 10 for details on using the upper paper tray.

Upgrading Memory

You can install Single Inline Memory Module (SIMM) to upgrade the on-board memory of the machine.

The machine is shipped from the factory with a 4MB SIMM, which can be replaced with an 8MB, 16MB or 32MB SIMM.

Use the following procedure to install 8MB, 16MB or 32MB SIMM.

Note

The following are the required specifications for a SIMM used with this machine: 72-pin, 60ns, Extend Date Out (EDO), parity/non-parity.

Important!

Make sure you touch some grounded metal object with your hand to discharge any electrostatic charge from your body before handling the SIMM.

1 Turn off the machine.

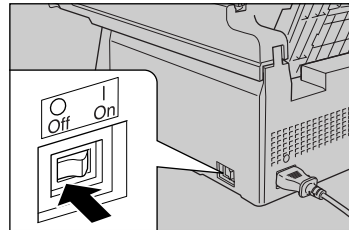

2 Remove the SIMM cover located on the left side of the machine.

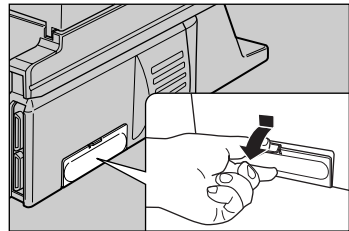

3 Pull apart the hooks on the both sides of the SIMM board that hold it in place.

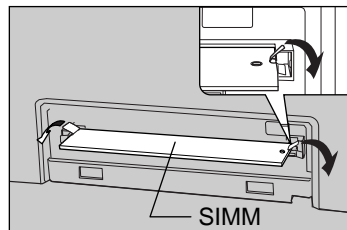

4 Carefully lift out the SIMM board currently installed on your printer.

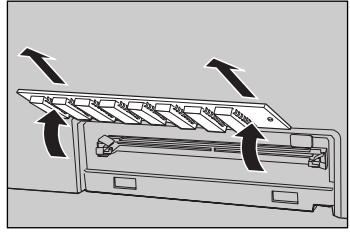

5 Angle the new SIMM board as shown in the illustration, and insert it down into the slot. Gently rock it back and forth until you hear it snap into place.

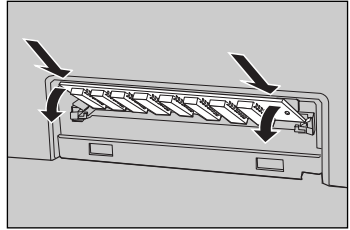

Important!

Make sure the SIMM board is oriented correctly when you insert it into the slot.

6 Make sure the hooks on the sides of the SIMM board snap securely into place.

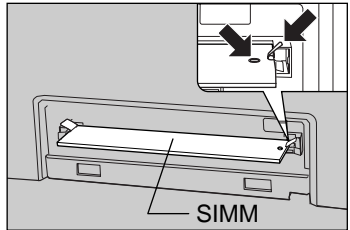

7 Replace the cover by inserting its tabs into the holes provided, as shown in the illustration.

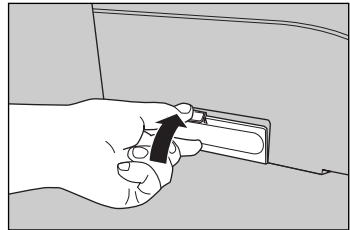

3. PRINTING AND SCANNING

When connected to a compatible PC, you can use this machine as a high performance laser printer and black and white scanner.

Important!

- Make sure that your PC parallel port is set to ECP. If it is not, please consult your PC manual on how to change it.

Note

- For information on PC hardware and software requirements, please read the README file on the CD.
- Printer drivers are provided for both Windows® 95/98 and Windows® 3.1, but the scanning feature requires Windows® 95/98.

Setting up

Before you can start printing and scanning you need to do the following if you have not done so already:

- Connect the machine to your PC
- Install the software drivers on your PC

Installing the Software Drivers

Follow the steps below to install the printer/scanner drivers on your PC.

- 1** Make sure the machine is connected to your PC and paper is loaded in the upper paper tray.

 *Connecting to a computer, See page 7*

 *Loading Paper, See page 10*

- 2** Switch the machine on.

- 3** Insert the provided software CD into your CD-ROM drive.

4 Do one of the following according to your operating system:**• Windows® 95/98**

Run the setup application. For example, if your CD-ROM is assigned to D, run “D:\Scan-in\Setup.exe”.

• Windows® 3.1

First copy the disk images under the directory named “3.1” on the CD-ROM to floppy disks. Then insert the first floppy disk into your floppy disk drive and run “install.exe”.

 **Note**

- *You cannot install from CD-ROM under Windows 3.1.*
- *Only the printer driver will be installed under Windows 3.1.*

5 Follow the instructions that appear on the display.

For detailed information on how to print and scan from your PC, please refer to the online help provided.

Features You Can Access From the Printer Driver

Printer Driver Contents

■ Paper Defaults

- Paper size : Size, Measurement Unit
- Page orientation : Portrait, Landscape
- Output : Copies, Print in reverse order
- Paper source : Source
- About

■ N-Up Printing

- Select a Layout Option : Normal, Reduce for N-up printing
(Print page borders ; 2 pages up/sheet ; 4 pages up/sheet)

■ Document

Document Type Settings

	Automatic	Photo (Grayscale)	Desktop Publishing	High Speed Draft	Business Graphics
Graphics Mode	Raster	Raster	GL/2	Raster	Raster
Font Resolution (dpi)	600	600	600	300	600
Graphics Resolution	High	High	High	High	High
Halftone	Screening	Screening	Screening	Screening	Dithering

- Job Settings : True Type Mode, Name

■ Configuration

- Device Configuration : Feeder ; Toner Save Mode ; Time-out

■ Fonts

- Font Manager (To add printer fonts)

■ Overlays

- Overlay Assignments : None, All pages, Odd/Even pages, First/Other pages
- Cover/Divider page Overlays
- Create New Overlay
- Manage Overlays : Get files from other sources to use as overlays, Send created overlays to other sources, Rename overlays, Remove overlays

Important!

After printing a large number of pages, wait a few minutes before turning off the machine.

Note

Be sure to use online help and Read me file of the printer driver to get the most out of all the printer features and functions.

Using the Second Printer (Additional Printer)

Use the following procedure to switch between this machine and a second printer when a second printer is connected.

Important!

If the second printer has a bi-directional mode, make sure you turn it off.

Note

Connecting a second printer, see page 15.

To print to the second printer

- 1** Press  **The Second Printer indicator lights.**

Important!

Whenever you change printers, be sure to also change to the appropriate printer driver on your computer.

Note

While the Second Printer Indicator is lit, print data from your computer passes through the machine to the second printer.

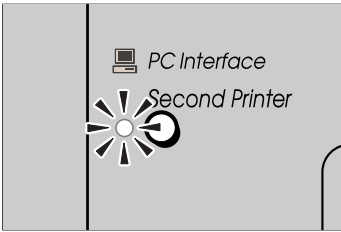

- 2** Perform the required print operation with the application you are using.

4. COPYING

Making a Copy

- 1** Lift the platen cover (①). Place the original face down at the arrow mark on the scale (②). Close the platen cover (③).

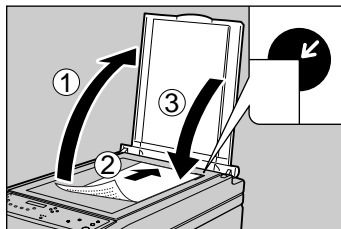

- 2** Press  to perform the copy operation.

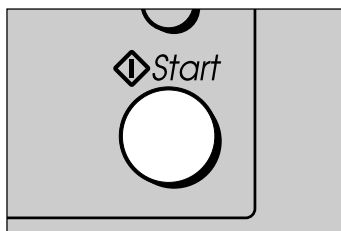

Important!

After copying a large number of pages, wait a couple of minutes before attempting to turn off the machine.

Note

When printing to label paper, envelopes, transparencies, or thin paper (60 g/m² or 16 lb), remove each printout as it comes out of the machine. If you don't, printed output can fall out of the output tray, and become curled.

Alignment of Originals

Align the original with the scale of the exposure glass.

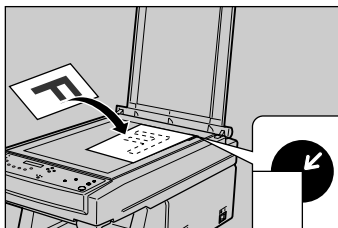

- When the original is a standard size such as A4 or Letter, align it to the indexes on the scale.
- When your original is not standard size, align the upper left edge of the original to the arrow mark on the scale.



For Type 2 Users



- When the original is smaller than the paper you are copying to, place a second sheet of paper that is larger than the paper you are copying to on top of the original when you place the original onto the exposure glass.

Making Multiple Copies

You can specify the number of copies to be printed by pressing  (to increase the number) or  (to reduce the number).

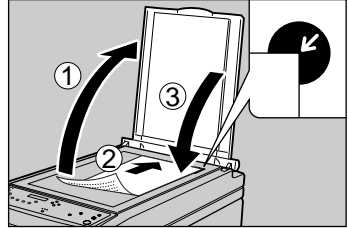
1 Lift the platen cover (①). Place the original face down at the arrow mark on the scale (②). Close the platen cover (③).



2 Press  or  until the desired number of copies appears.



 **Note**

You can specify the number of copies in the range of 01 to 99.



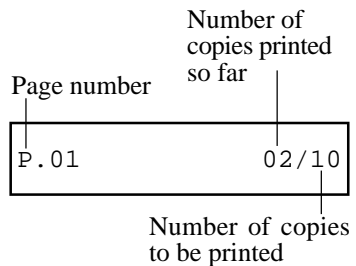

3 Press  to perform the copy operation.

 **Note**

During the copy operation, the display shows the number of copies printed so far and that to be printed. For example, 02/10 appears while the second copy of a run of 10 copies is being printed.



 **Tips**

- Press  to clear the setting after the copying has been finished.
-  (Type 1) or  (Type 2) produces copies at a faster speed, but it can also result in a loss of printout quality.
- With a Type 2 machine, using  also activates the Sort feature automatically.

Making a Book Copy

When copying from a book, the thickness of the book should be no more than 30mm (1.18").

1 Lift the platen cover.

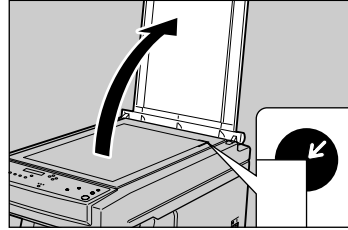

2 Open to the page you want to copy and lay the page face down on the exposure glass. Be sure to align one of the corners of the page with the arrow mark on the scale.

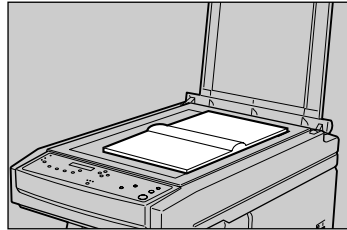

3 Lower the platen cover.

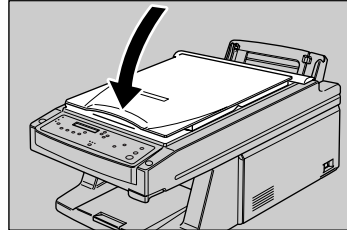

4 Press  to perform the copy operation.

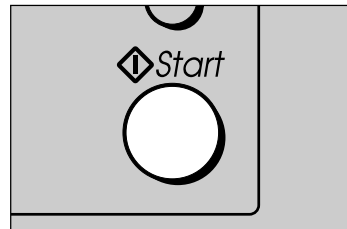

Zoom (In 1% Increments)

Zoom allows you to tune the preset reduction and enlargement factors to exactly the value you want. You can change the zoom factor in increments of 1%.

To use zoom

Setting Range

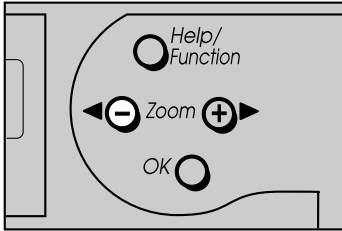

200 to 50%

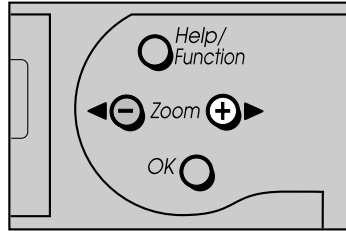

50 to 200%

- 1** Lift the platen cover (①). Place the original face down at the arrow mark (②). Close the platen cover (③).

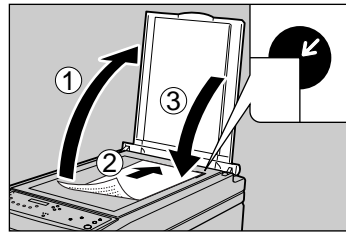

- 2** Press **Zoom** (decrease) or **Zoom** (increase) until the desired size ratio appears.

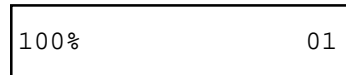

- 3** Press **Start** to perform the copy operation.



Note
Press **Clear Modes** to clear the setting after copying.

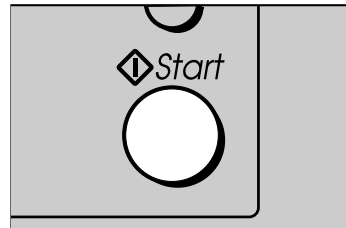

Adjusting the Copy Image

To select the resolution/photo setting

1 Lift the platen cover (①). Place the original face down at the arrow mark on the scale (②). Close the platen cover (③).

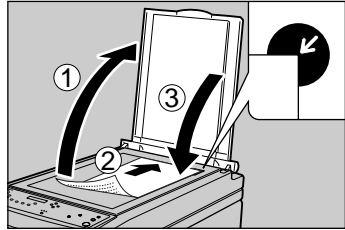

2 Press the Copy Mode key to specify the resolution or halftoning method for the copy operation.

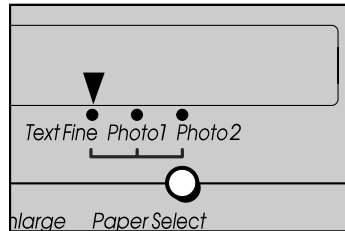

3 A pointer (▼) moves on the display to indicate the current setting. The following describes when you should use each setting.

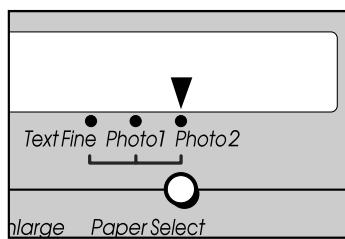

Setting	Use for:
[Text Fine]	Copying text
[Photo1]	Copying photographs
[Photo2]	Copying mixed text and photographs

Note

If the memory size of your machine is 4MB, the machine automatically switches from Photo2 to Photo1 in the following cases.

- ◆ when the ^{Memory Copy} (Type 1) or ^{Sort/Memory Copy} (Type 2) key is on
- ◆ when you make multiple copies using the ADF (Type 2 only)

4 Press  to perform the copy operation.

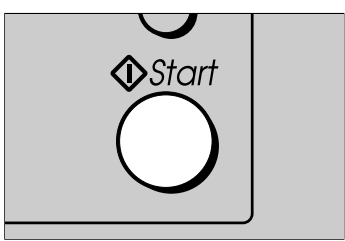

Note

Press ^{Clear Modes}  to clear the setting after copying.

To adjust the image density

1 Lift the platen cover (①). Place the original face down at the arrow mark (②). Close the platen cover (③).

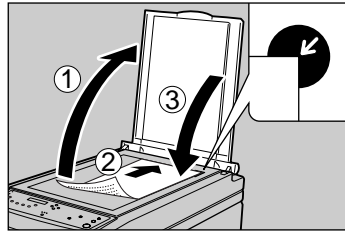

2 Press the Density key to select the image density.

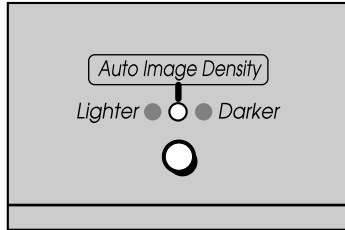

- Select [Lighter] to make the image lighter.

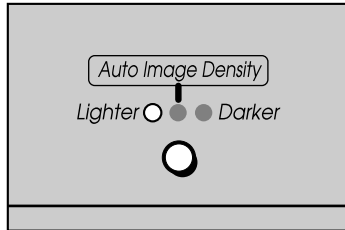

- Select [Darker] to make the image darker.

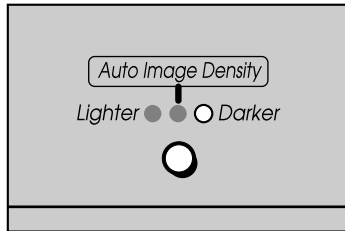

3 Press  to perform the copy operation.

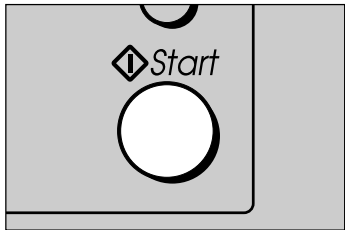

Note
 Press  to clear the setting after copying.

Setting an Original on the ADF (Type 2 only)

You can load up to 10 sheets of plain paper (80 g/m² or 20 lb) at a time into the Automatic Document Feeder (ADF).

Important!

Check to make sure that the ADF cover is securely closed before using it.

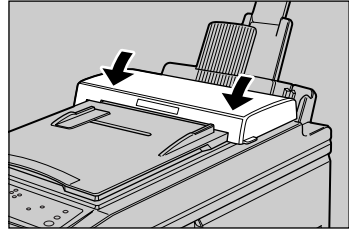

- 1 Fan the stack of originals. Never try to place more than 10 sheets of plain paper onto the ADE.**

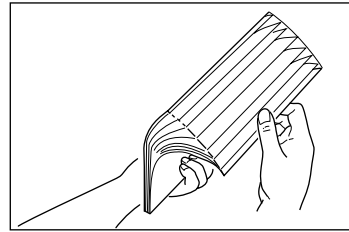

- 2 Straighten up all four sides of the stack, by tapping them on a desk or table top.**

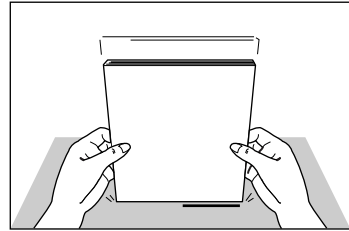

- 3 Place the stack of originals face down on the ADF and slide the document guide against the side of the stack.**

Note

The side of the original to be copied should be face down.

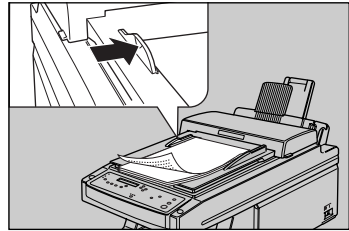

- 4 Insert the stack of originals along the document guide into the ADE.**

Note

Insert your stack of originals into the ADF until it stops. If you do not push it right in, the machine will not detect the stack.

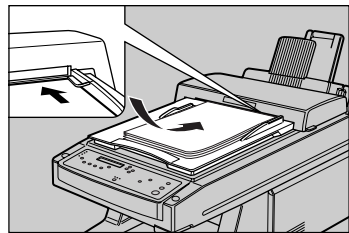

5 Stretch the extend tray that supports the originals.

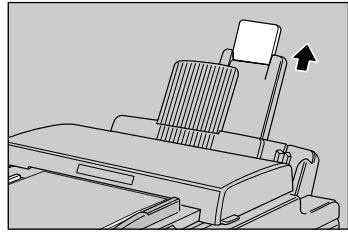

6 Press  to perform the copy operation.

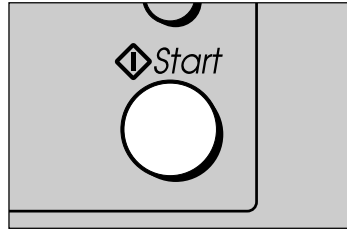

 **Note**

- If an original becomes misfed during feeding by the ADF, press  to stop the operation. Refer to “Clearing a Paper Misfeed” on page 48.
- We recommend you use text mode when copying with the ADF.
- We recommend you copy photo originals from the exposure glass for best results.

Originals that do not meet the following requirements can cause paper misfeeds, and even damage the machine.

■ Requirements

- Thickness 0.05mm to 0.2mm (0.002" to 0.08")
- Weight 60 to 90 g/m² (16lb to 24lb)
- Clear markings Markings on the originals must be clear to be read correctly.
- Uniform page size All pages should be the same size.
- Page condition Avoid using originals that are bent, curled, damaged, or stapled, and originals printed on coated paper, carbon paper, or photographic paper.

Sorting Output (Type 2 only)

The following example shows how output is affected by turning sorting on and off.

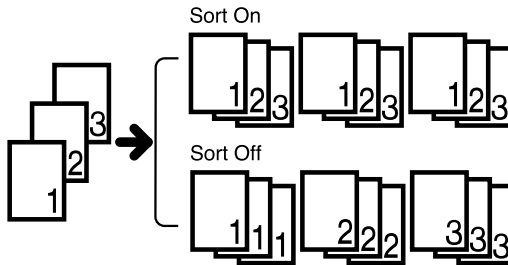

! Important!

The sort operation requires scanning of all your originals into memory before starting the copy operation. The number of originals that can be scanned at one time depends on how much memory you have installed.

☛ *Upgrading Memory, see page 21*

To turn sorting on and off

1 Set the originals on the ADE

Note

☛ *Setting an originals on the ADF, see page 35.*

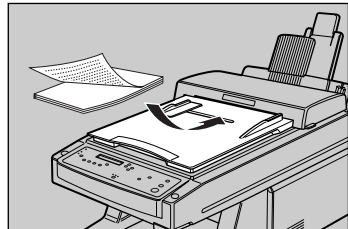

2 Sorting is activated when the ▼ pointer is visible on the display above Sort/Memory Copy. Press to select sorting on and off (no pointer).

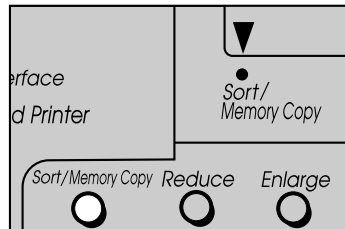

3 When you press  to start the copy operation, all of the originals on the ADF are scanned into memory before they are printed.

 **Note**

Press  to clear the setting after copying.

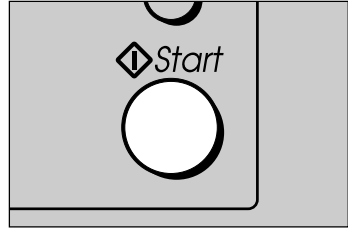

5. TROUBLESHOOTING

General

Status	Cause	Remedy	Page
Nothing happens when the machine is turned on.	Power cord is not connected.	Correctly connect the power cord to the machine and plug it into a outlet.	p.8
	SIMM is not installed correctly	Install the SIMM correctly.	p.21
	SIMM does not meet the required specifications.	Use a SIMM with the required specifications.	p.21
Paper misfeeds when the machine is turned on for the first time after the installation.	Paper was loaded in the machine before the machine was turned on.	Remove the paper, turn the machine off and then back on. After machine initialization is complete, load the paper back into the machine.	p.8
After installing a SIMM board, the memory value that appears on the machine's display does not match the amount of memory installed.	SIMM does not meet the required specifications.	Use a SIMM with the required specifications.	P.21

Printing and Copying (1/2)

Status	Cause	Remedy	Page	
Frequent paper misfeeds.	The upper paper tray is not set correctly	Set the upper paper tray correctly.	p.4	
	Improper paper.	Use paper of the correct size and thickness.	p.9	
	Paper is not set correctly in the upper paper tray.	Realign the paper with the paper guide, and if necessary, fan the paper stack.	p.10	
	Paper is curled or damp.	Uncurl the paper.		p.10,12,18
		Insert paper into the upper paper tray from the least-curved side.		p.10,12
		Set paper face down if necessary.		p.10,12,18
	Avoid using damp paper.		—	
Too much paper is loaded in the machine.	Remove some of the paper.		p.10,14	
Paper is loaded incorrectly.	Check the paper and realign it if necessary.		p.10,18	

Printing and Copying (2/2)

Status	Cause	Remedy	Page
Frequent paper mis-feeds.	Attempting to print on both sides of the paper.	Print on only one side. Two-side printing is not supported by this machine.	p.10,18
	Printing onto loosely stacked envelopes	Flatten the envelopes to expel all air.	p.14
	Misfeeding of the envelope flap.	Make sure that envelope flaps are closed (folded down).	p.14
Part of the image is unclear.	Toner is distributed unevenly in the toner cassette.	Remove the toner cassette, gently rock it left and right a few times, and replace it into the machine.	p.52
Black lines on the printout.	Heat damage to the toner cassette caused by turning off the machine too soon after copying a large number of pages.	Replace the toner cassette.	p.52
Dark areas along the sides of the printout.	Turning off the machine too soon after printing or copying a large number of pages.	Replace the toner cassette.	p.52

Printing

Status	Cause	Remedy	Page
Abnormal or unexpected printing results.	Use of wrong cable.	Use the cable that comes with this machine.	p.7
	Wrong printer driver settings.	Change to the correct printer driver settings.	p.23
	Attempting to print from a DOS application at 600 dpi.	Change to 300 dpi.	p.58
Parts of the image are not printed out.	The correct paper size is not specified.	Specify the paper size using the operation panel.	p.19
Cannot print from a second printer.	Second printer is not connected correctly.	Check connections and make corrections, if necessary.	p.15
	Second printer is not selected.	Press ^{Second Printer}  so the indicator above it is lit.	p.26
	Incorrect settings of the second printer driver.	Use the printer driver of the second printer to turn off bi-directional printing.	p.26

Copying

Status	Cause	Remedy	Page
"Error 90" appears on the display, and the copy operation is aborted when copying from the exposure glass.	Locked scanner.	Unlock the scanner lock, turn the machine off and then back on.	p.3
Frequent original mis-feeds with ADF	Original is not set correctly.	Set the original correctly.	p.35
	Curled original(s).	Straighten out the original(s).	p.35
		Insert the original(s) from the least-curved side.	p.35
	Incorrect original specifications.	Use originals of the correct size, thickness, and quantity.	p.36
Original is not fed from the ADF	ADF cover is open.	Close the ADF cover.	p.35
Original is not fed out properly.	The document output tray is not set correctly.	Set the document output tray and the small pieces of plastic film correctly.	p.6
Periodic black marks on printed output.	Cleaning pad is not installed.	Correctly install the cleaning pad.	p.51
Black lines and marks on printed output when copying from the exposure glass.	Copying to small-size paper with the Type 2 machine.	Place a sheet of the same size as the paper you are printing onto behind the original.	p.27
	Different size original and copy paper.		
	Non-white original background.	Adjust the print density.	p.34
	Dirty platen cover or exposure glass.	Clean the platen cover and exposure glass.	p.51
Black and white lines on printed output when using the ADF.	Dirty ADF transport path.	Clean the ADF transport path.	p.51
Output too light.	Low contrast original.	Adjust the print density.	p.34
Unclear photographic images.	Copying in Text Fine Mode.	Use the Copy Mode key to select the Photo1 or Photo2 Mode.	p.33
Parts of the original image are not copied.	The correct paper size is not specified	Specify the paper size using the operation panel.	p.19

Scanning



Status	Cause	Remedy	Page
PC scanning does not function properly.	The PC parallel port is not set to ECP.	Consult your PC manual on how to set your parallel port to ECP.	p.23

Error Messages (1/2)

The table below explains the error messages that may appear on the display and the appropriate action to take.

Message	Cause	Remedy	Page
"Close cover"	Top unit is open.	Close the top unit. If a copy job is in progress, set the copy quantity again.	p.3
"Add paper"	Machine is out of paper.	Load paper. If a copy job is in progress, set the copy quantity again.	p.10,18
"Toner near end"	Machine is almost out of toner.	Prepare a toner cassette for replacement.	—
"Add Toner"	Toner cassette is not loaded correctly.	Correctly load the toner cassette into the machine.	p.2
	Machine is out of toner.	Replace the toner cassette, and set the copy quantity again during a copy job.	p.52
"Clear paper"	Paper misfeed, or paper will not feed at all.	Remove the misfed paper. If a copy job is in progress, set the copy quantity again. If paper persistently misfeeds, carry out the procedure on page 49.	p.44,49
"Memory overflow"	Not enough memory capacity (PC printing only).	Either lower the printer driver's "Resolution" setting or increase memory capacity by installing a larger SIMM. Press any operation panel key to clear the error message from the display.	p.21,25
"Remove original" (when original is set in ADF)	Original misfeed, or paper will not feed at all.	Remove the original from the ADF, and set the copy quantity again.	p.48
"Original left" and "on glass"	An original may be under the platen cover.	Remove the original. If there is no original, open the platen cover and close it again.	—
"Memory full" and "Press Stop"	Too much sort copy data.	Press  to cancel sort copy, and perform the copy operation without sorting. If you need to print big sort copy jobs, increase memory capacity.	p.21,37

Error Messages (2/2)

Message	Cause	Remedy	Page
“Memory full” and “Press Start”	Too many sort copy pages.	Press  to print pages already stored in memory to cancel the job, press  . If you need to print big sort copy jobs, increase memory capacity.	p.21, 37
Error 90	Locked scanner.	Unlock the scanner lock, turn the machine off and then back on.	p.3
Error XX	Possible machine defect.	Turn power off and then back on again.	p.8

If you have a problem with the machine and you can not resolve it by referring to the information in this chapter, contact your service representative.

In case of “Error XX” messages, be sure to turn off the machine before calling.

Clearing a Paper Misfeed

This section describes how to clear a paper misfeed when one occurs.

⚠ CAUTION

When removing misfed paper, do not touch the fusing section because it could be very hot.

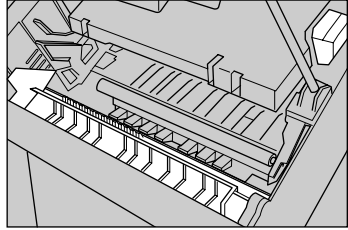

⚡ Important!

Hold a misfed sheet with both hands and slowly pull it out. Do not use a tool, such as a screwdriver or tweezers, as this may damage the unit.

Type 1

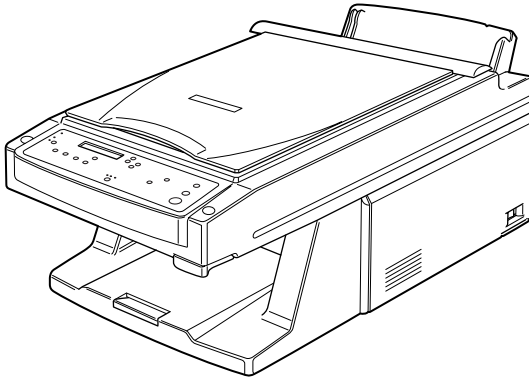

- 1** Pull the top release lever (①) and open the top unit (②).

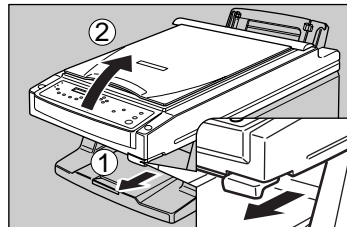

- 2** Pull out the toner cassette.

🔧 Note

- Be sure to hold the toner cassette by its handle.
- Keep the toner cassette horizontal to avoid spilling the toner.

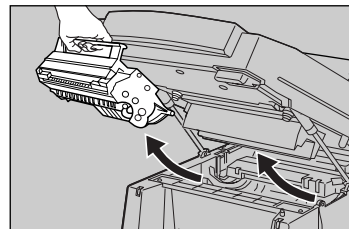

- 3** Pressing down on the paper release lever (blue) on the right side, pull out the misfed paper.

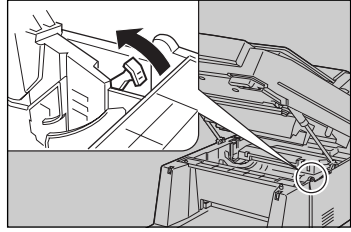

- 4** Pull out the misfed paper in the directions indicated by the arrows in the illustrations.

Note

- If you are using the paper feed unit (option) and cannot clear the misfeed using this procedure, use the procedure on page 48 instead.
- Sometimes toner may get on your hands.

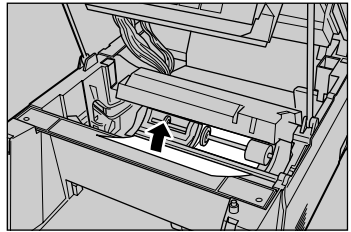
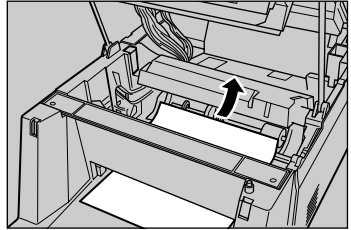

- 5** Install the toner cassette into the machine.

Note

- Be sure to hold the toner cassette by its handle.
 - Keep the toner cassette horizontal to avoid spilling the toner.
- ➔ Install the starter toner cassette, see page 2.

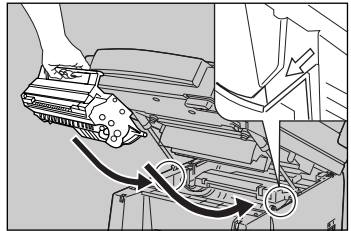

- 6** Close the top unit.

Note

- If “Clear Paper” is still displayed after you clear the jam, there may be paper jammed in another part of the machine. Check all areas described in this section.

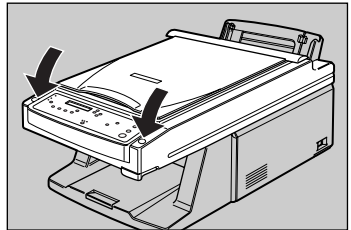

Important!

If a paper misfeed occurs during a copy job, be sure to specify the desired copy quantity again.

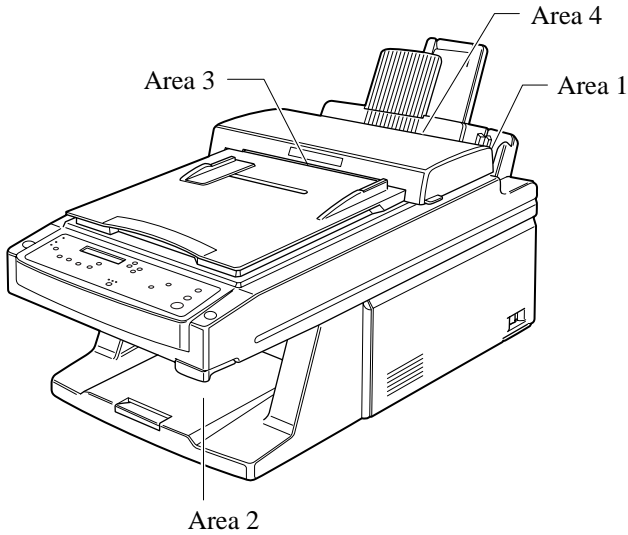
Type 2**Area 1 or 2**

- 1** Pull the top release lever (①) and open the top unit (②).

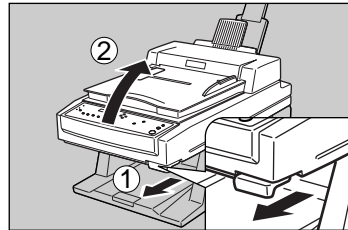

- 2** Pull out the toner cassette.

Note

- Be sure to hold the toner cassette by its handle.
- Keep the toner cassette horizontal to avoid spilling the toner.

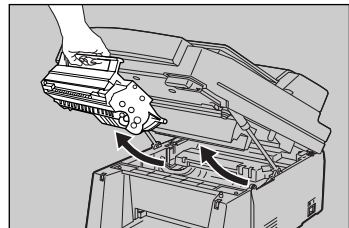

3 Push back the blue paper release lever located on the right.

Note

The lever releases pressure on the paper. If you do not push it back, you could damage the machine when removing paper.

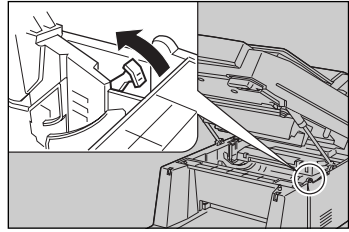

4 Pull out the misfed paper in the directions indicated by the arrows in the illustrations.

Note

- If you are using the paper feed unit (option) and cannot clear the misfeed using this procedure, use the procedure on page 48 instead.
- Sometimes toner may get on your hands.

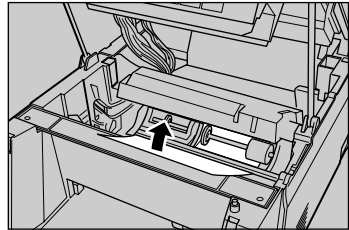
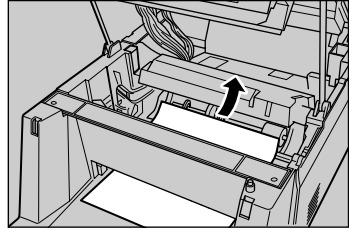

5 Install the toner cassette into the machine.

Note

- Be sure to hold the toner cassette by its handle.
- Keep the toner cassette horizontal to avoid spilling the toner.

 Install the starter toner cassette, see page 2.

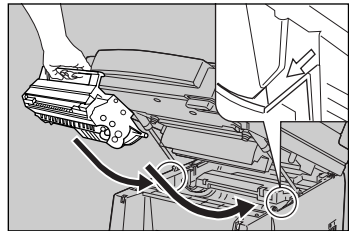

6 Close the top unit.

Note

- If “Clear Paper” is still displayed after you clear the jam, there may be paper jammed in another part of the machine. Check all areas described in this section.

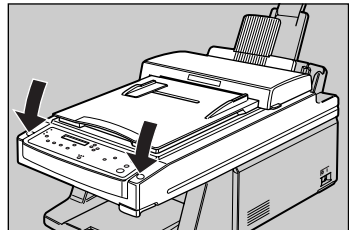

Important!

If a paper misfeed occurs during a copy job, make sure to specify the desired copy quantity again.

Area 3 or 4**1** Open the ADF cover. **Note**

Be sure to open the ADF cover before pulling out the misfed original. Failure to do so can result in damage to the original.

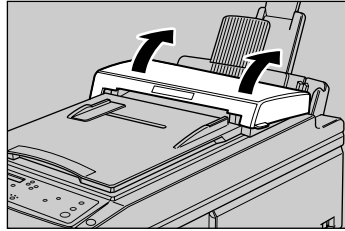
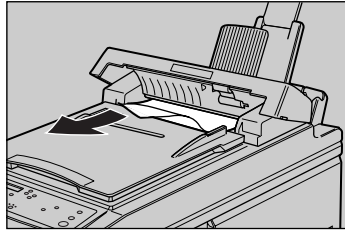
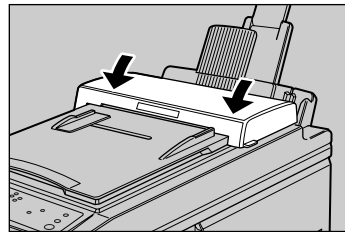
**2** Pull out the misfed original.**3** Close the ADF cover, and make sure it locks securely into place. **Important!**

If copying was in progress, be sure to specify the desired copy quantity again.

Paper feed unit

Use the following procedure when the misfed paper cannot be removed using the procedure on page 44 (for Type 1) or page 46 (for Type 2).

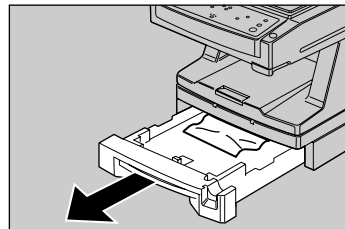
1 Pull out the paper tray.

- 2** Pull out the misfed paper.

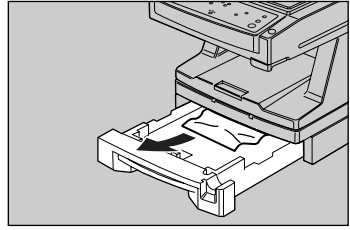

- 3** Slide the paper tray back into the paper feed unit until it locks into place.



Note

For how to set paper in the optional paper feed unit, see page 16.

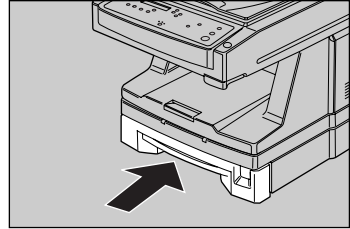

Tip

If you cannot find a remedy for unexpected printout results here, check the printer driver's online help for other useful information.

When paper will not feed

If paper has completely stopped feeding, check using the following procedure. Please keep this sheet in a secure place together with the Operation Manual.

- 1** Remove all paper.

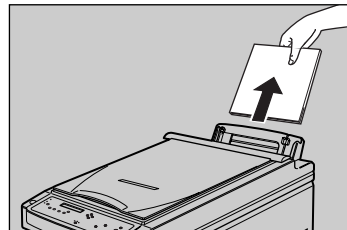

- 2** Pull the top release lever (①) and open the top unit (②).

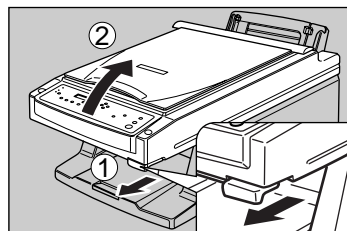

3 Pull out the toner cassette.

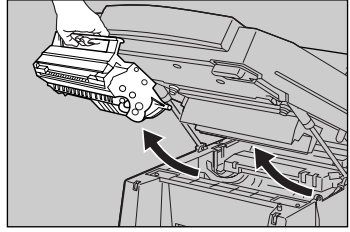

4 Pull the blue key-shaped pawl located deep inside on the right where the toner cassette was set forward.

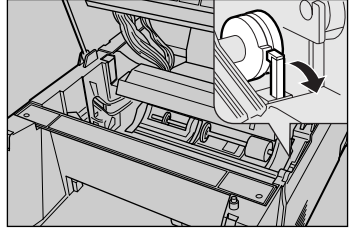

5 Install the toner cassette into the machine.

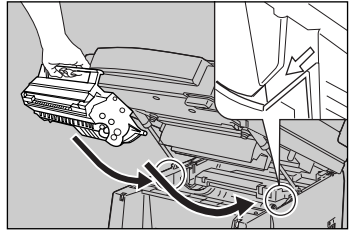

6 Close the top unit. When the top unit is closed, the motor will start running. When the sound of the motor stops, set paper in the original position and continue with normal operation.

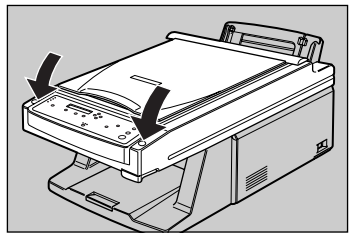

6. USER MAINTENANCE

Daily Maintenance

Clean with a damp cloth and wipe dry.

 **Note**

Turn off the machine before cleaning

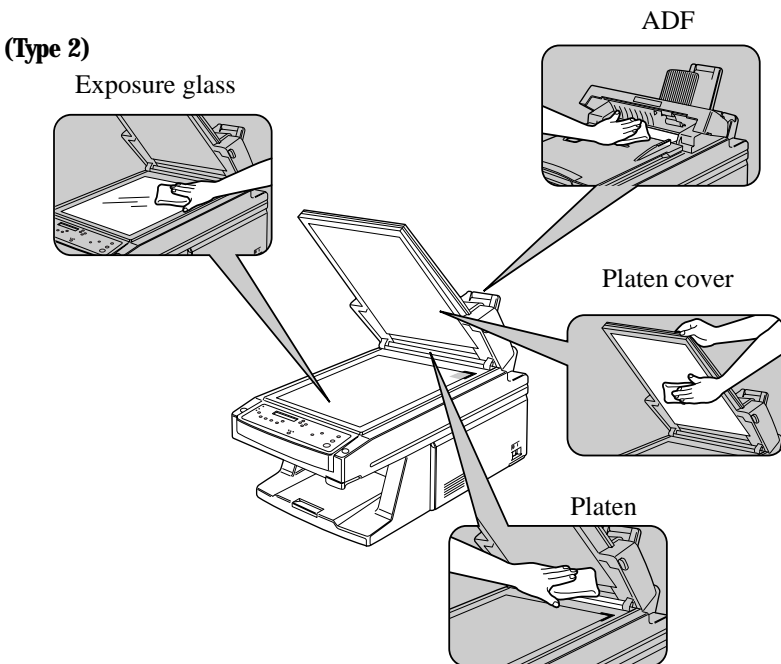
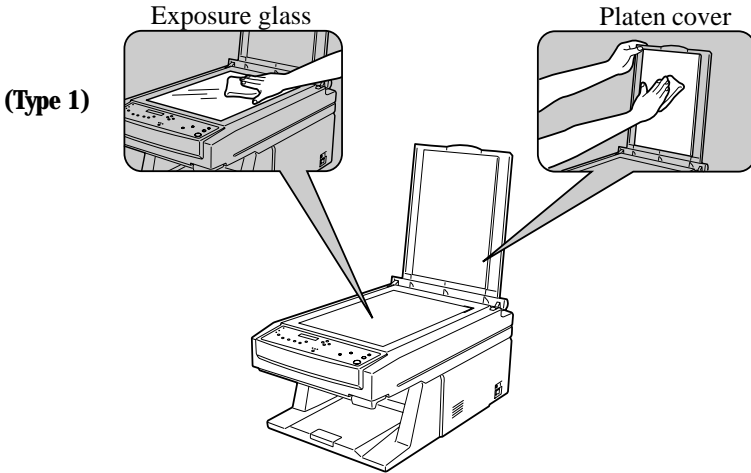

Replacing the Toner Cassette And the Cleaning Pad

Printing on A4 size paper under the recommended temperature and humidity conditions noted in the table under “Environment” on page 1, you can expect a toner cassette to print approximately 3,000 pages when you are printing typical business letters that have text covering 5% of the total surface. The starter cassette that comes with the machine can print approximately 1,000 pages. Pages that contain graphics use more toner and shorten the life of a toner cassette.

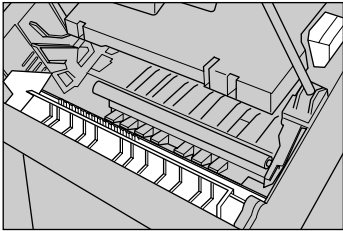
⚠ WARNING	
🚫	Do not incinerate used toner or toner containers. Toner dust might ignite when exposed to an open flame. Dispose of the used toner cassettes according to local regulations for plastics.
🚫	This machine has been tested for safety using this supplier's parts and consumables. We recommend you only use these specified supplies.
⚠ CAUTION	
⚠	When replacing the toner cassette and cleaning pad, do not touch the fusing section because it could be very hot.
	

1 Open the box of the new toner cassette and check to make sure it contains a toner cassette and cleaning pad.

Note

Be sure to hold the toner cassette by its handle.

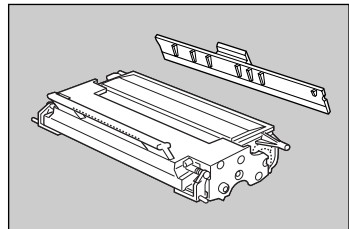

2 Pull the top release lever (①) and open the top unit (②).

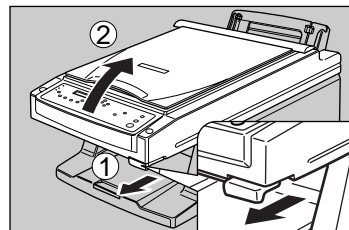

- 3** Hold the toner cassette by its handle and pull it out.

 **Note**

Keep the toner cassette horizontal to avoid spilling the toner.

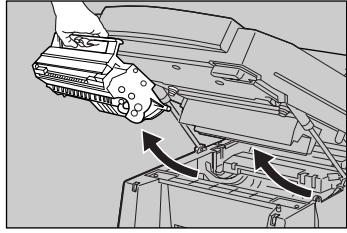

- 4** Remove the old cleaning pad.

 **Note**

Be sure to grasp the green handle when removing the cleaning pad.

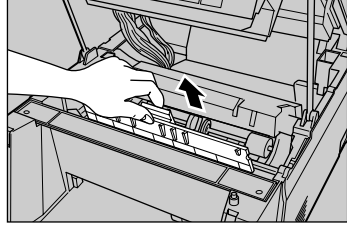

- 5** Insert the new cleaning pad into place by grasping the green handle.

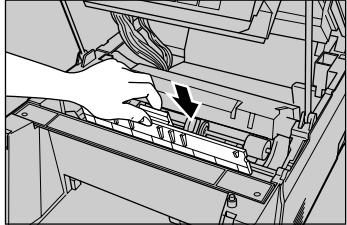

- 6** Press down gently but firmly on both sides of the pad to make sure that it is inserted as far as it can go.
Do not forget to install the cleaning pad whenever you install a new toner cassette.

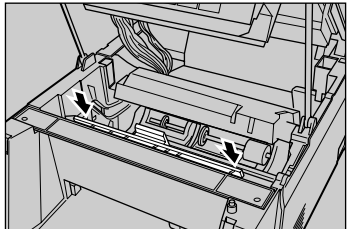

- 7** Prepare the new toner cassette. Holding the toner cassette by its handle, gently shake it side to side 5 or 6 times to evenly distribute the toner inside.

 **Note**

Be sure to hold the toner cassette by its handle.

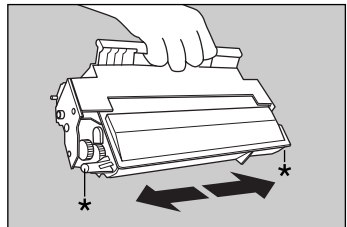

- 8** Look inside the machine and note the locations of the arrows that indicate the toner cassette guides on either side.

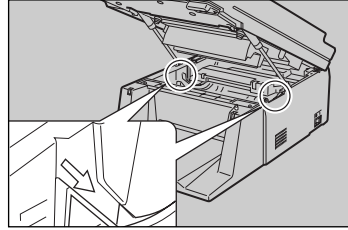

- 9** Make sure the plastic pins (marked with “*” in the illustration next to step above) on either side of the toner cassette slide along the guides inside the machine.

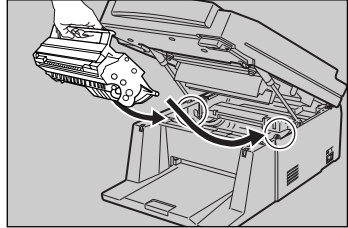

 **Note**

Be sure to hold the toner cassette by its handle.

- 10** To close the top unit, press down firmly but gently on both sides of it until the top unit closes and clicks securely into place.

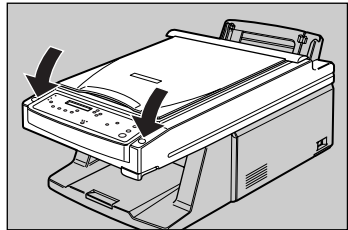

 **Note**

Background gray cast is sometimes evident just after installing a new toner cassette.

Storage

Paper

Paper should always be stored properly. Improperly stored paper might result in poor image reproduction, creased copies, or paper misfeeds. Generally, avoid paper curling and absorption of moisture.

- Avoid storing paper in humid areas. In high-temperature and high-humidity, or low-temperature and low-humidity conditions, store paper in a vinyl bag.
- Do not store paper where it will be exposed to heat.
- Store on a flat surface.
- Use older stock first.
- Do not lay heavy objects on paper.
- Keep open reams of paper in the package, and store as you would unopened paper.

Toner Cassette

- Keep the toner cassette inside the packaging that it comes packed in whenever it is removed from the machine.
- Store horizontally in a cool, dark place.
- Never store a toner cassette where it will be exposed to heat.
- Do not lay heavy objects on the toner cassette.

CAUTION

Keep toner cassettes out of children's reach.

7. TECHNICAL REFERENCE

Printing the Help List

You can print out the help list.

- 1** While the machine is not performing any other operation, press . The message “Prt Help List” appears.

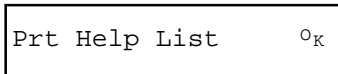

- 2** Press *OK* .

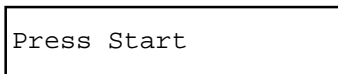

- 3** Press  to print the Help List.



Note

Print on A4, Letter, or Legal paper.

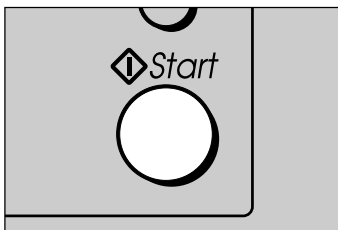

Selecting the Language



The language for the display can be selected from the following:

1 Press  *Help/Function*.



2 Press *Zoom*  or  *Zoom* until "2 Language" appears.



3 Press *OK*  and press *Zoom*  or  *Zoom* until the desired language appears.

4 Press *OK* .

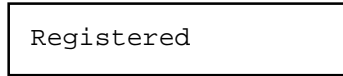

 **Note**

- Do not carry out any operations while "Registered" appears on the display.
- The setting is not registered, if *OK*  is not pressed.



Selecting 300 dpi or 600 dpi

Set the printer to 300 dpi if the designated output is not obtained when printing using a DOS application compatible with the 300 dpi PCL printer.

1 Press  *Help/Function*.



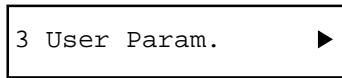

Prt Help List 

2 Press *Zoom*  **▶** or **◀**  *Zoom* until “3 User Param.” appears. The messages change in the following order.



3 User Param. 

3 Press *OK*  and press *Zoom*  **▶** to move the flashing block cursor until it appears in the position shown in the illustration to the right.



02:0010  000 



4 Press  **+** to change the setting to 1 or 0, as desired.

Display	Heater status
02:0010 0000	600 dpi (default setting)
02:0010 1000	300 dpi

 **Note**

The bits other than the one highlighted in the illustration are unrelated to this setting.

5 Press **OK** . **Note**

- To cancel this change, press  or  instead of **OK** . “Please wait” and “Not Registered” appear on the display.
- Do not carry out any operations while “Registered” appears on the display.

Please wait

Registered

100%

01

Economy Mode

The Economy mode can be selected to save power. If no operation is performed for 5 minutes, the display becomes blank and all the indicators go out. If no operation is performed in the next 10 minutes or 235 minutes (according to the setting), the heater turns off.

The economy mode is on as the default setting.

Economy mode	Operation panel off	Heater off
ON (default setting)	5 minutes	15 minutes (including time when operation panel is off)
OFF	5 minutes	240 minutes (including time when operation panel is off)

 **Note**

- During the Economy Mode, the heater turns back on in the following cases.
 - ◆ when any key on the operation panel is pressed
 - ◆ when the platen cover is opened
 - ◆ when paper is set in or removed from the upper paper tray (Type 2)
 - ◆ when the tray of the paper feed unit (option) is pulled out or pushed back into the machine
 - ◆ When the top unit is opened.
 - ◆ When an original is set in or removed from the ADF.
 - ◆ On initiation of PC printing.
- When a key on the operation panel is pressed to turn the heater on, the key does not perform its normal function.
- After the heater is turned back on, the previous %, quantity, and Sort On settings are cleared.

Changing the Economy Mode

Hold down the Clear modes key for approximately 1 second until the Economy mode indicator lights or goes out, as required.

Economy Mode ON



Economy Mode OFF

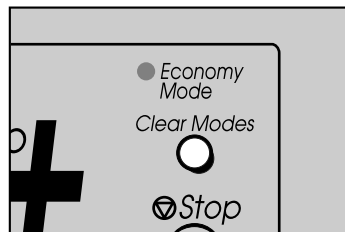

Selecting Toner Saving Mode

The toner saving mode status has two settings.

1 Press “Prt Help List” appears.



2 Press **Zoom** or **Zoom** until “3 User Param.” appears. The messages change in the following order.

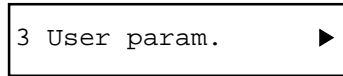

3 Press **OK** and press **Zoom** to move the flashing block cursor until it appears in one of the positions shown in the illustration to the right.

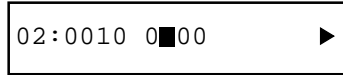

Note

The bits other than the one highlighted in the illustration are unrelated to this setting.

4 Press **+** to change the bit setting to 1 or 0, as desired.

Display	Heater status
02:0010 0000	Off (Default)
02:0010 0100	On (Density will be lighter)

5 Press **OK** .

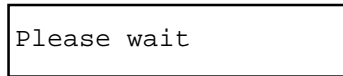

Note

- To cancel this change, press or instead of **OK** . “Please wait” and “Not Registered” appear on the display.
- Do not carry out any operations while “Registered” appears on the display.

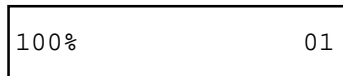
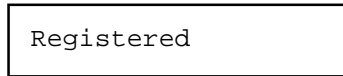

7. TECHNICAL REFERENCE

8. SPECIFICATIONS

General Specifications

Type 1	Type 1, Type 2												
<p>Paper Capacity Upper tray plain paper (80 g/m²: 20 lb.) 100 sheets Option paper unit plain paper (80 g/m²: 20 lb.) 250 sheets Output tray Capacity plain paper (80 g/m²: 20 lb.) 50 sheets</p> <p>Memory 4 MB (Expandable to 8 MB, 16 MB or 32 MB) EDO SIMM, 60 ns, 72 pin</p> <p>Dimensions 249mm × 352mm × 576mm (H×W×D) 9.81" × 13.87" × 22.69" (H×W×D)</p> <p>Weight 15.0 kg (33.08 lb)</p>	<p>Power Supply AC 220 to 240 V 50/60 Hz</p> <p>Power Consumption</p> <table data-bbox="655 427 924 598"> <tr><td>Max</td><td>480 W</td></tr> <tr><td>Printing (Average)</td><td>215 W</td></tr> <tr><td>Copying (Average)</td><td>240 W</td></tr> <tr><td>Stand-by (Average)</td><td>75 W</td></tr> <tr><td>PC-Scan (Average)</td><td>75W</td></tr> <tr><td>Economy Mode</td><td>15 W</td></tr> </table> <p>Operating Environment Temperature /Humidity 10°C (50°F) to 35°C (95°F) 15% to 80%</p> <p>Machine Life 30,000 sheets/5 years</p>	Max	480 W	Printing (Average)	215 W	Copying (Average)	240 W	Stand-by (Average)	75 W	PC-Scan (Average)	75W	Economy Mode	15 W
Max	480 W												
Printing (Average)	215 W												
Copying (Average)	240 W												
Stand-by (Average)	75 W												
PC-Scan (Average)	75W												
Economy Mode	15 W												
<p>Type 2</p> <p>Paper Capacity Upper tray plain paper (80 g/m²: 20 lb.) 100 sheets Option paper unit plain paper (80 g/m²: 20 lb.) 250 sheets ADF (Auto Document Feeder) Capacity plain paper: A4, IT-LG (80 g/m²: 20 lb) 10 sheets Output tray Capacity plain paper (80 g/m²: 20 lb.) 50 sheets</p> <p>Memory 4 MB (Expandable to 8 MB, 16MB or 32MB) EDO SIMM, 60 ns, 72 pin</p> <p>Dimensions 297mm × 352mm × 576mm (H× W× D) 11.70" ×13.87"× 22.69" (H× W× D)</p> <p>Weight 15.5 kg (34.18 lb)</p>	<p>Printer Duty 6,000 sheets/1 month</p> <p>Scanner Duty 2,000 sheets/1 month</p> <p>Paper Sizes Plain paper A4 = 210 mm × 297 mm A5 = 148 mm × 210 mm Letter (LT) = 8 1/2" × 11" Legal (LG) = 8 1/2" × 14" Half Letter = 5 1/2" × 8 1/2" F4 = 8 1/4" × 13"</p> <p>Envelopes C5 = 162 mm × 229 mm C6 = 114 mm × 162 mm DL = 110 mm × 220 mm</p> <p>Other Transparencies Label Paper</p>												

Printing Specifications

<p>Printer Language PCL 5e compatible</p> <p>Print Resolution 600 dpi × 600 dpi 1200 dpi × 600 dpi (enhanced)</p> <p>Print Speed 6 ppm (pages per minute)</p> <p>Paper/Media Types Plain paper Envelopes Transparencies Label paper</p> <p>Paper Weight 60 to 90 g/m² (16 to 24 lb)</p> <p>Interface IEEE 1284</p>	<p>Resident Font</p> <ul style="list-style-type: none"> • Dutch 801 SWC • Dutch 801 Italic SWC • Dutch 801 Bold SWC • Dutch 801 Bold Italic SWC • Swiss 742 SWC • Swiss 742 Italic SWC • Swiss 742 Bold SWC • Swiss 742 Bold Italic SWC • Swiss 742 Condensed SWC • Swiss 742 Condensed Italic SWC • Swiss 742 Condensed Bold SWC • Swiss 742 Condensed Bold Italic SWC • Incised 901 SWC • Incised 901 Italic SWC • Incised 901 Bold SWC • Fixed Pitch 810 Courier Roman SWC • Fixed Pitch 810 Courier Bold SWC • Fixed Pitch 810 Courier Italic SWC • Fixed Pitch 810 Courier Bold Italic SWC • Fixed Pitch 850 Letter Gothic 12 pitch/text SWC • Fixed Pitch 850 Letter Gothic Bold 12 pitch/text SWC • Fixed Pitch 850 Letter Gothic Italic 12 pitch/text SWC • Flareserif 821 SWC • Flareserif 821 Extra Bold SWC • Ribbon 131 SWC • Wingbats SWM
---	---

Scanner Specifications

<p>Configuration Flatbed / ADF</p> <p>Document Size LG, LT, HLT, A4, A5, B5</p> <p>Optical Resolution 300dpi</p> <p>Scanning Resolution 1bit 100 × 100, 150 × 150, 200 × 200, 300 × 300, 400 × 400, 600 × 600 dpi 8bit 300 × 300 dpi</p>	<p>Grey scale 256 levels (8-bit)</p> <p>Interface IEEE 1284 ECP mode</p> <p>Compatibility TWAIN</p> <p>ADF Up to 10 pages of 80g/m² (20lb), Plain paper</p> <p>Maximum scanning size 212 × 351.6 mm</p> <p>OS Windws 95/98 only</p>
--	--

Copying Specifications

<p>Copy Speed 6 cpm (copy per minute)</p> <p>Warm-up Time 30 seconds or less</p> <p>First copy 17 seconds or less</p> <p>Multiple Copies Up to 99 copies</p> <p>Copy Reduction and Enlargement 50%, 71%, 82%, 87%, 93%, 115%, 122%, 141%, 200%</p> <p>Paper/Media Types Plain paper Envelopes Transparencies Label paper</p>	<p>Paper Weight 60 to 90 g/m² (16 to 24 lb)</p> <p>Original Types Exposure glass (Type 1/Type 2) Sheet/Book ADF (Type 2) Up to 10 pages of 80 g/m² (20 lb), Plain paper</p> <p>Maximum Original Size Legal (LG) = 8 1/2" × 14"</p> <p>Copy Resolution 600 dpi × 600 dpi</p>
--	---

INDEX

- I**
- 1 to 1 Copy 27
- A**
- Additional Printer 15
- Auto image density 34
- Automatic Document Feeder (ADF) ix
- Setting an original 35
- B**
- Book Copy 29
- C**
- Check Display x
- Clearing a Paper Misfeed 43
- cleaning pad 52
- Computer port viii, ix
- Connecting a Second Printer
(Additional Printer) 15
- Connecting to a computer 7
- Connector 16
- Copy Mode key xi
- Corner guides 16, 18
- D**
- Daily Maintenance 51
- Density key x
- Display xi
- Document guides ix
- Document output tray ix
- Installing 6
- E**
- Economy Mode 60
- Economy Mode/Clear Modes key xi
- Enlarge x
- Enlargement 30
- envelopes 14
- Exposure glass viii, ix
- Extend tray viii, ix
- F**
- Front guide 16, 19
- Front paper support 16
- H**
- Help List 56
- Help/Function xi
- I**
- image density 34
- Installing
- Document output tray 6
- Toner cassette 2
- Upper paper Tray 4
- L**
- label paper 14
- Language 57
- Limit mark 10, 16, 18
- Loading Paper 10
- Loading
- plain paper 10
- small size paper 12
- other media 14
- Location 1
- M**
- Memory Copy (Type 1 only) xi, 28
- Metal plate 10, 16, 18
- Multiple Copies 28
- O**
- OK xi
- Operation Panel viii, ix, x
- Original
- Setting (Exposure glass) 27
- Setting (ADF) 35
- Requirements (ADF) 36
- Original Guide ix
- Output tray viii, ix

	P		
Paper and Other Media		9	
Paper Select		x	
paper size			
Changing		19	
Specifying (upper)		11, 13	
Specifying (lower)		19	
Paper size indicator		16, 19	
Paper Feed Unit		16	
PC Interface		x	
Photo1		33	
Photo2		33	
Platen cover		viii, ix	
Power socket		viii, ix	
Power switch		viii, ix	
printer driver			
Windows 95		23	
Windows 3.1		24	
	Q		
Quantity keys		x	
	R		
Reduce		x	
Reduction		30	
Replacing			
Toner cassette		52	
cleaning pad		52	
resolution/photo setting		33	
	S		
Safety Information		i	
Scanner lock		viii, ix	
Unlocking		3	
Second Printer (Additional Printer) port		viii, ix	
Second Printer (Additional Printer)		x	
Connecting		15	
Using		26	
Side guide		16, 19	
SIMM cover		viii, ix	
SIMM		21	
Small size paper feed access panel		viii, ix	
small size paper		12	
sort		37	
Sort/Memory Copy (Type 2 only)		xi, 28, 33	
SPECIFICATIONS		62	
Start		x	
Stop		xi	
Storage		55	
	T		
Text Fine		33	
Toner cassette			
Installing		2	
Replacing		52	
Top release lever		viii, ix	
Top unit		viii, ix	
transparencies		14	
TROUBLESHOOTING		39	
Type 1		viii	
Type 2		ix	
	U		
Upgrading Memory		21	
Upper paper tray		viii, ix, 4, 10	
User Parameter		58, 61	
Using the Second Printer (Additional Printer) ..		26	
	Z		
Zoom		xi, 32	